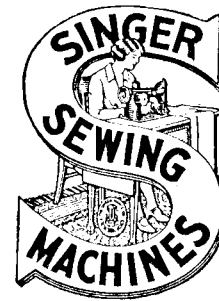


Form 18507
August, 1931
PRINTED IN U. S. A.

LIST OF PARTS



MACHINES
Nos. 57-2 to 57-4
and 57-14

From the library of: Diamond Needle Corp

THE SINGER MANUFACTURING COMPANY

COPYRIGHT, U. S. A., 1918, 1922 and 1931,
BY THE SINGER MANUFACTURING Co.
ALL RIGHTS RESERVED FOR ALL COUNTRIES

INDEX

	PAGE
ATTACHMENTS AND ACCESSORIES.....	30
BOBBIN WINDER.....	34
DRIVING ATTACHMENT.....	34
FOOT LIFTER PARTS.....	36
IRON BASE.....	30
KNEE LIFTER PARTS.....	37
LAP SEAM FELLER PARTS.....	31
MACHINE No. 57-2.....	7
“ “ 57-3.....	15
“ “ 57-4.....	21
“ “ 57-14.....	26
NUMERICAL LIST OF PARTS.....	41
OBSOLETE PARTS.....	39
SHIRT CLOSING PARTS (FOR MACHINE No. 57-2).....	33
STAYING PARTS (FOR MACHINE No. 57-2).....	33
THREAD UNWINDER.....	38

From the library of: Diamond Needle Corp

INSTRUCTIONS FOR ORDERING

In ordering from this list, use **ONLY** the part NUMBER in the **FIRST** column.

The number stamped on a Sewing Machine Part is in every case the number of the single part only.

Every combination of parts sent out as such has its specific number, which, although not stamped on the parts, must be used when ordering the combination.

Each number always indicates the **SAME PART** in whatever list it appears, or for whatever machine.

The letters after some of the numbers indicate the style of finish only, as follows:

- A—Hardened, Polished, Nickel Plated and Buffed
- B—Polished, Nickel Plated and Buffed
- C—Hardened Only
- D—Polished Only
- E—Soft, Not Polished
- F—Hardened and Polished
- H—Blued
- J—Nickel Plated Only
- K—Hardened and Nickel Plated
- L—Brass Plated
- M—Oxidized
- N—Japanned, Dull
- P—Japanned, Bright
- R—Merlized
- T—Copper Plated
- T. A.—Hardened, Polished, Copper and Nickel Plated and Buffed
- T. B.—Copper and Nickel Plated and Polished
- T. J.—Copper and Nickel Plated Only
- T. K.—Hardened, Copper and Nickel Plated
- T. M.—Copper Plated and Oxidized
- T. L.—Copper and Brass Plated
- U—Zinc Plated
- V—Silver Plated
- W—Polished and Nickel Plated
- Z—Chromium Plated
- Z. B.—Polished, Nickel Plated, Buffed and Chromium Plated
- Z. J.—Nickel and Chromium Plated

These letters **MUST BE USED** when they appear in the list; and **AFTER** the number **as** in the list.

In this series:

- 1 to 1500 and 50001 to 51500 are Screw Numbers
- 1501 to 1800 and 51501 to 51800 are Nut Numbers
- 1801 to 2000 and 51801 to 52000 are Roller Numbers
- 2001 to 50000 and 52001 and upward are numbers of Machine Parts

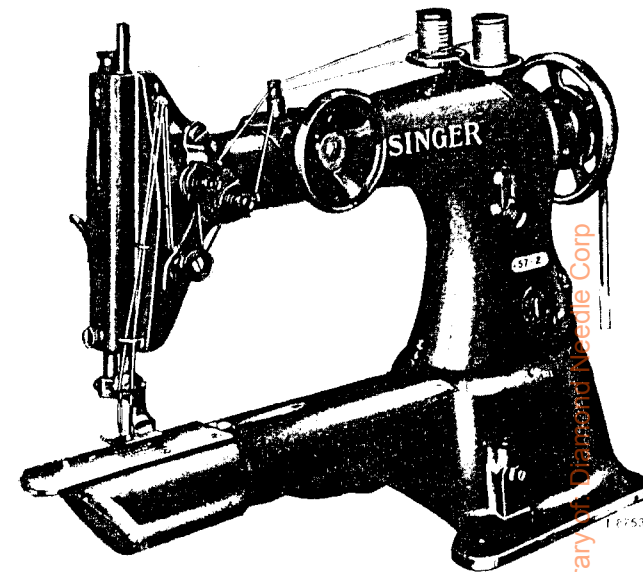
The figures in the second column refer only to the plates, illustrating the parts, and are **NOT TO BE USED** in ordering.

Parts marked with an asterisk (*) are furnished only when repairs are made at factory.

When ordering parts which differ as to **Gauge** (the distance between seams) the Gauge, as well as the **Number must be given** on order.

LIST OF PARTS COMPLETE

FOR



MACHINE No. 57-2

FOR CLOTH. TWO NEEDLES, TWO SHUTTLES; WIDEST GAUGE $\frac{5}{16}$ INCH, NARROWEST GAUGE $\frac{1}{32}$ INCH. DROP FEED UP THE ARM.

NO.	PLATE	NAME
*21001	—	Arm with 11104.....
8582	1150	“ Dowel Pin.....
12453	1150	“ Oil Tube for intermediate bearing....
12454	1150	“ “ “ with 52045, for oiling 12409
11119	1150	“ “ “ “ 52045, for oiling 19156
20502	1150	“ “ “ 29599, for oiling 12496
29599	7429	“ “ “ Packing (felt) for 20502....
52045	7438	“ “ “ “ (braided cotton) for 11119 and 12454.....
748E	1157	Arm Screw (back).....
854E	1159	“ “ (front).....

NO.	PLATE	NAME
21002	1167	Arm Shaft.....
*11104	—	“ “ Bushing (front).....
12357	1142	“ “ Flanged Bushing (back).....
448c	1158	“ “ “ “ “ Set Screw.....
21026	1166	“ “ Gear with 453c and 454c.....
23724	7429	“ “ “ Pin.....
453c	1158	“ “ “ Position Screw.....
454c	1158	“ “ “ Set Screw.....
144d	1157	“ “ Screw.....
12480	1143	“ Side Cap.....
219j	1157	“ “ “ Screw.....
12193	1143	“ “ Cover.....
286d	1158	“ “ “ Thumb Screw.....
21004	1140	“ “ Wheel with two 450c.....
23724	7429	“ “ “ Pin.....
450c	1158	“ “ “ Set Screw.....
21005	1166	“ “ “ Shaft.....
21006	1166	“ “ “ “ Collar with 449c.....
23724	7429	“ “ “ “ “ Pin.....
449c	1158	“ “ “ “ “ Set Screw.....
21027	1166	“ “ “ “ Gear with 453c and 454c.....
23724	7429	Arm Side Wheel Shaft Gear Pin.....
453c	1158	“ “ “ “ “ Position Screw.....
454c	1158	“ “ “ “ “ Set Screw.....
21008	1166	“ “ “ “ “ Cover.....
21009	—	“ “ “ “ “ 21008 with 460c and 21019.....
21010	1166	Arm Side Wheel Shaft Gear Cover complete, Nos. 21009 and 21038.....
219j	1157	Arm Side Wheel Shaft Gear Cover Screw.....
2415	1140	“ Spool Bracket.....
15063	1140	“ “ “ 2415 with two 12403.....
145d	7430	“ “ “ Screw.....
12403	1150	“ “ “ Spool Pin and Thread Eyelet.....
11241	1142	Arm Spool Bracket Spool Pin Washer (cloth).....
12358	1140	Balance Wheel (power) light rim, 2 $\frac{3}{8}$ in. pulley, with two 448c.....
448c	1158	Balance Wheel Set Screw.....
20197	1141	Crank Connecting Rod with 20198 and two 896E.....
*20198	—	Crank Connecting Rod Cap.....
896E	1157	“ “ “ “ Screw.....
908c	1158	“ “ “ Hinge Screw.....
1619E	1159	“ “ “ “ Nut.....

NO.	PLATE	NAME
*21011	—	Cylinder, 2 $\frac{1}{8}$ in. diam.....
20641	1143	“ Cover.....
20505	1142	“ Feed Cover.....
219b	1157	“ “ “ Screw.....
19301	—	Face Plate.....
19305	1143	Face Plate complete, Nos. 19155, 19301 and 19327.....
190b	1157	Face Plate Screw.....
19327	7428	“ “ Thread Guard (lower) with 12152.....
12152	1150	Face Plate Thread Guard (lower) Rivet.....
19155	1150	“ “ “ “ (upper) with 12152.....
12152	1150	Face Plate Thread Guard (upper) Rivet.....
286b	1158	“ “ Thumb Screw.....
3033	1145	Feed Connecting Link.....
375c	1158	“ “ “ Hinge Screw.....
4518E	1159	“ “ “ “ Nut.....
20630	1179	“ Dog, 22 teeth (16 teeth to the inch) for $\frac{1}{16}$ in. to $\frac{3}{32}$ in. gauges.....
20508	1152	Feed Dog, 13 teeth (12 teeth to the inch) for $\frac{3}{32}$ in. to $\frac{5}{32}$ in. gauges.....
20515	1152	Feed Dog, 23 teeth (22 teeth to the inch) for $\frac{3}{32}$ in. to $\frac{5}{32}$ in. gauges.....
20510	1152	Feed Dog, 13 teeth (12 teeth to the inch) for $\frac{3}{32}$ in. to $\frac{5}{32}$ in. gauges (spiked teeth) for heavy work on duck, overalls, etc....
20509	1153	Feed Dog, 13 teeth (12 teeth to the inch) for $\frac{1}{64}$ in. to $\frac{3}{16}$ in. gauges.....
20511	1153	Feed Dog, 13 teeth (12 teeth to the inch) for $\frac{1}{64}$ in. to $\frac{3}{16}$ in. gauges (spiked teeth) for heavy work on duck, overalls, etc....
20507	1151	Feed Dog, 16 teeth (12 teeth to the inch) for $\frac{1}{4}$ in. to $\frac{5}{16}$ in. gauges.....
20514	1175	Feed Dog, 21 teeth (16 teeth to the inch) for $\frac{1}{4}$ in. to $\frac{5}{16}$ in. gauges.....
20512	1151	Feed Dog, 16 teeth (12 teeth to the inch) for $\frac{1}{4}$ in. to $\frac{5}{16}$ in. gauges (spiked teeth) for heavy work on duck, overalls, etc....
704c	1157	Feed Dog Screw.....
3074	1142	“ Eccentric with 446c.....
446c	1158	“ “ Set Screw.....
20518	1141	“ Forked Connection with 20519 and two 175E.....
*20519	—	Feed Forked Connection Cap.....
175E	1157	“ “ “ “ Screw.....
20520	1145	“ Raising Fork.....

NO.	PLATE	NAME
157E	1157	Feed Raising Fork Screw.....
20521	1142	" Regulator.....
1128E	7430	" " Hinge Screw.....
283D	7430	" " Thumb Screw.....
20522	1141	" Rock Shaft.....
20523	1141	" " " " Arm with 460c.....
2049	1150	" " " " Pin.....
460c	1158	" " " " Set Screw.....
295c	1158	" " " " Screw Center.....
1513J	1159	" " " " " Nut.....
21012	1141	" Rod.....
923E	1158	" " Hinge Screw.....
18014	1142	Needle Bar (hollow).....
12382	1144	" " Connecting Link with 794E..
794E	1144	" " " " Adjusting Screw.....
*12383	—	Needle Bar Connecting Stud.....
12384	1144	Needle Bar Connecting Stud complete, Nos. 453c, 1904 and 12383.....
1904	1144	Needle Bar Connecting Stud Roller (roller only).....
453c	1158	Needle Bar Connecting Stud Set Screw...
20188	1142	" " Crank with 858c and 1065c..
1065c	7430	" " " " Position Screw.....
858c	1158	" " " " Set Screw.....
936E	1158	" " Screw Bushing.....
20524	1150	" Clamp with two 209F.....
2273	1150	" " Pin.....
209F	1157	" Set Screw.....
19386	1142	Oscillating Rock Shaft.....
19387	—	Oscillating Rock Shaft complete, Nos. 4784, 12388 and 19386.....
12388	1142	Oscillating Rock Shaft Hinge Pin.....
448c	1158	" " " " " Set Screw
4784	1150	" " " " Oil Pad.....
21013	1141	" Shaft.....
19496	—	" Crank.....
19388	1149	Oscillating Shaft Crank complete, Nos. 457c, 1518E, 19390 and 19496.....
2049	1150	Oscillating Shaft Crank Pin.....
457c	7430	" " " " Set Screw.....
19389	1149	" " " " Slide Block.....
226E	7438	" " " " " CapScrew
12424	1149	" " " " " " " "
		Washer.....
969c	1149	Oscillating Shaft Crank Slide Block Screw Stud.....

NO.	PLATE	NAME
1518E	1159	Oscillating Shaft Crank Slide Block Screw Stud Nut.....
19390	1149	Oscillating Shaft Crank Slide Block com- plete, Nos. 226E, 969c, 12424 and 19389
16015	1150	Oscillating Shaft (back bearing) Oil Tube
20563	1142	Presser Bar (hollow).....
12326	1145	" " Guide Bracket with 453c....
453c	1158	" " " " Set Screw....
2062	1145	" " Lifter.....
689c	1157	" " " " Hinge Screw.....
1520E	1159	" " " " " Nut.....
12327	1145	" " Lifting and Releasing Lever Bracket.....
11167	1142	Presser Bar Spring (light) .051 wire.....
12139	1142	" " " (medium) .055 wire....
20023	1142	" " " (heavy) .063 wire....
11170	1150	" " " Washer.....
330J	1158	" Foot Clamping Screw.....
20530	1150	" " Hinge Pin.....
20645	—	" " Plate.....
21016	—	" " Shank.....
20646	1156	Presser Foot (hinged) complete, for staying seams, Nos. 330J, 20530, 20645 and 21016.....
330J	1158	Presser Foot Clamping Screw.....
20530	1150	" " Hinge Pin.....
20647	—	" " Plate.....
21016	—	" " Shank.....
20648	1156	Presser Foot (hinged) complete, for strip folding, with guide for opening seams Nos. 330J, 20530, 20647 and 21016....
330J	1158	Presser Foot Clamping Screw.....
20530	1150	" " Hinge Pin.....
21015	—	" " Plate.....
21016	—	" " Shank.....
21014	1151	Presser Foot (hinged) complete, for gen- eral work, Nos. 330J, 20530, 21015 and 21016.....
21017	1156	Presser Foot (solid) with 330J.....
20711	1171	" " (strip folding) with 330J....
20712	1171	" " (tube) with 330J.....
330J	1158	" " Clamping Screw.....
20530	1150	" " Hinge Pin.....
20753	—	" " Plate.....
21016	—	" " Shank.....

From the library of Diamond Needle Corp

NO.	PLATE	NAME
20754	1171	Presser Foot (hinged) complete, with guide on bottom of plate to the right of needle holes, Nos. 330J, 20530, 20753 and 21016
330J	1158	Presser Foot Clamping Screw.....
20530	1150	" " Hinge Pin.....
20776	—	" " Plate.....
21016	—	" " Shank.....
20777	7436	Presser Foot (hinged) complete, with tube for tape and guide for opening seams, Nos. 330J, 20530, 20776 and 21016.....
688J	1158	Pressure Regulating Thumb Screw.....
19131	1148	Shuttle (inside) Bobbin.....
20774	—	" " " Case.....
20536	1148	" " " " Latch and Position Finger.....
2521	1148	Shuttle (inside) Bobbin Case Latch and Position Finger Spring.....
592E	1148	Shuttle (inside) Bobbin Case Latch and Position Finger Stop Screw.....
20538	1147	Shuttle (inside) Bobbin Case Position Plate
935E	1157	" " " " " " " " Screw.....
20533	1148	Shuttle (inside) Bobbin Case complete, Nos. 591F, 592E, 2521, 19149, 20536 and 20774.....
20540	1148	Shuttle (inside) Body.....
591F	1148	" " Tension Regulating Screw.....
19149	1148	" " " Spring.....
20531	1148	" " 1 1/8 in. diam., Nos. 19131, 20533 and 20540.....
19131	1148	Shuttle (outside) Bobbin.....
20775	—	" " " Case.....
20537	1148	" " " " Latch and Position Finger.....
2521	1148	Shuttle (outside) Bobbin Case Latch and Position Finger Spring.....
592E	1148	Shuttle (outside) Bobbin Case Latch and Position Finger Stop Screw.....
20539	1147	Shuttle (outside) Bobbin Case Position Plate
190D	1157	" " " " " " " " Screw.....
20534	1148	Shuttle (outside) Bobbin Case complete, Nos. 591F, 592E, 2521, 19150, 20537 and 20775.....
19137	1148	Shuttle (outside) Body.....
591F	1148	" " Tension Regulating Screw.....
19150	1148	" " " Spring.....

NO.	PLATE	NAME
20532	1148	Shuttle (outside) 1 1/8 in. diam., Nos. 19131, 19137 and 20534.....
20783	7436	Shuttle Driver and Feed Lifting Eccentric
2019	1150	" " " " " " " " Pin.....
20544	—	Shuttle Race Body.....
20545	1147	" " Loop Separator.....
662D	1158	" " " " " Screw.....
20543	1147	Shuttle Race complete, Nos. 935E, 20538, 20539, 20544, 20545 and two each 190D and 662D.....
131E	1157	Shuttle Race Screw.....
2921	1146	Tension Disc.....
19191	1146	" Plate, for upper tension, with 19231.....
134D	1157	Tension Plate Screw.....
1560C	1146	" Regulating Thumb Nut.....
19192	1146	" Releaser.....
12397	1145	" Releasing Lever.....
12398	1145	" " " Hinge Pin.....
12329	1145	" " " Spring.....
19193	1146	" " " (intermediate) Hinge
19231	1146	" " " " " Hinge Block.....
2269	1146	Tension Releasing Lever (intermediate) Hinge Pin.....
19194	1146	Tension Releasing Lever (intermediate) Spring.....
916C	1146	Tension Screw Stud.....
44209	—	" " " 916C with 1560C.....
1547D	1146	" " " Nut.....
2923	1146	" Spring.....
12149	1150	" Thread Guard.....
19195	1146	Tension complete (upper) with Tension Release, Nos. 2269, 19191, 19193, 19194, two each 1547D, 2923, 19192, 44209 and four 2921.....
19159	1149	Thread Guide Body.....
19161	1149	" " Cap.....
19160	1149	" " Roller.....
905D	1157	" " Screw.....
19162	—	Thread Guide complete (roller) Nos. 905D and 19159 to 19161.....
21019	1166	Thread Retainer Body.....
460C	1158	" " Set Screw.....
21020	1166	" " Thread Separator.....
210958	7428	" Retaining Collar.....

From the library of: Grand Needle Corp.

NO.	PLATE	NAME
210993	7428	Thread Retaining Sleeve.....
210992	7428	" " Spring.....
21037	7428	" " Stud.....
21038	—	Thread Retainer complete, Nos. 21020, 21037, 210958, 210992 and 210993.....
24129	1144	Thread Take-up Crank.....
3094	1144	" " " Wedge.....
690E	1144	" " " " Screw....
19156	1144	" " " Lever.....
775E	1144	" " " Cap Screw.....
12166	1144	" " " Hinge Pin.....
12409	1144	" " " Link.....
11204	1144	" " " " Hinge Pin...
430c	1144	" " " " " " "Set Screw.....
19157	1144	Thread Take-up Lever complete, Nos. 12166, 12409 and 19156.....
19158	1150	Thread Take-up Spring.....
7336	1149	" " " Regulator.....
448c	1158	" " " " " Set Screw
20552	1175	Throat Plate for 20507, 20512 and 20514
20553	1176	" " " 20508, 20510 and 20515
20554	1176	" " " 20509 and 20511.....
20751	1178	" " " 20630.....
691F	1158	" " " Screw.....
20561	1164	Drip Pan.....

Genuine Singer Needles and their Containers are marked with the Company's Trade Mark "SIMANCO." 1

Needles in Containers marked "For Singer Machines" are not Singer made needles. 2

LIST OF PARTS COMPLETE FOR MACHINE No. 57-3

FOR CLOTH. ONE NEEDLE; DROP FEED UP THE ARM;
FEED BOTH SIDES OF THE NEEDLE

NO.	PLATE	NAME
*21022	—	Arm with 11104.....
8582	1150	" Dowel Pin.....
12453	1150	" Oil Tube for intermediate bearing...
12454	1150	" " " with 52045, for oiling 12409
11119	1150	" " " " " " " 12408
20502	1150	" " " " 29599, for oiling 20197
29599	7429	" " " Packing (felt) for 20502...
52045	7438	" " " " (braided cotton for 11119 and 12454.....
748E	1157	Arm Screw (back).....
868E	1157	" " (front).....
21002	1167	" Shaft.....
*11104	—	" " Bushing (front).....
12357	1142	" " Flanged Bushing (back).....
448c	1158	" " " " " Set Screw
21026	1166	" " Gear with 453c and 454c.....
23724	7429	" " " Pin.....
453c	1158	" " " Position Screw.....
454c	1158	" " " Set Screw.....
144D	1157	" " Screw.....
12480	1143	" Side Cap.....
219J	1157	" " " Screw.....
12193	1143	" " Cover.....
286D	1158	" " " Thumb Screw.....
21004	1140	" " Wheel with two 450c.....
23724	7429	" " " Pin.....
450c	1158	" " " Set Screw.....
21005	1166	" " " Shaft.....
21006	1166	" " " " Collar with 449c..
23724	7429	" " " " " Pin.....
449c	1158	" " " " " Set Screw..
21027	1166	" " " " " Gear with 453c and 454c.....
23724	7429	Arm Side Wheel Shaft Gear Pin.....
453c	1158	" " " " " Position Screw.....
454c	1158	Arm Side Wheel Shaft Gear Set Screw...
21023	1170	" " " " " Cover.....
219J	1157	" " " " " " Screw

NO.	PLATE	NAME
12403	1150	Arm Spool Pin and Thread Eyelet.....
11241	1142	" " " Washer (cloth).....
12358	1140	Balance Wheel (power) light rim, 2 $\frac{3}{8}$ in. pulley, with two 448c.....
448c	1158	Balance Wheel Set Screw.....
20197	1141	Crank Connecting Rod with 20198 and two 896E.....
*20198	—	Crank Connecting Rod Cap.....
896E	1157	" " " " " Screw.....
908c	1158	" " " " " Hinge Screw.....
1619E	1159	" " " " " Nut.....
*21024	—	Cylinder, 2 $\frac{7}{8}$ in. diam.....
20641	1143	" Cover.....
20505	1142	" Feed Cover.....
219J	1157	" " " " " Screw.....
12366	—	Face Plate.....
12367	1170	Face Plate complete, Nos. 2827, 12150 and 12366.....
190D	1157	Face Plate Screw.....
12150	7428	" " Thread Guard (lower) with 12152.....
12152	1150	Face Plate Thread Guard (lower) Rivet..
2827	7428	" " " " (upper) with 8505.....
8505	7428	Face Plate Thread Guard (upper) Rivet..
286D	1158	" " Thumb Screw.....
3033	1145	Feed Connecting Link.....
375c	1158	" " " " " Hinge Screw.....
1518E	1159	" " " " " Nut.....
20656	1189	" Dog, 18 teeth (16 teeth to the inch) for shirt work.....

NOTE: Feed Dog No. 20656 is sent with this machine unless another Feed Dog is specified on order

20662	1190	Feed Dog, 15 teeth (16 teeth to the inch) for tailor work.....
20664	1191	Feed Dog, 13 teeth (14 teeth to the inch) for shirt work.....
20685	1193	Feed Dog, 20 teeth (16 teeth to the inch) for overall work.....
704c	1157	Feed Dog Screw.....
3074	1142	" Eccentric with 446c.....
446c	1158	" " Set Screw.....
20518	1141	" Forked Connection with 20519 and two 175E.....
*20519	—	Feed Forked Connection Cap.....
175E	1157	" " " " " Screw.....

NO.	PLATE	NAME
20520	1145	Feed Raising Fork.....
704c	1157	" " " " " Screw.....
20521	1142	" Regulator.....
1128E	7430	" " " " " Hinge Screw.....
283D	7430	" " " " " Thumb Screw.....
20522	1141	" Rock Shaft.....
20523	1141	" " " " " Arm with 460c.....
2049	1150	" " " " " Pin.....
460c	1158	" " " " " Set Screw.....
295c	1158	" " " " " Screw Center.....
1513J	1159	" " " " " Nut.....
21012	1141	" Rod.....
923E	1158	" " " " " Hinge Screw.....
12381	1170	Needle Bar (hollow).....
12382	1144	" " " " " Connecting Link with 794E.....
794E	1144	" " " " " Adjusting Screw.....
*12383	—	Needle Bar Connecting Stud.....
1904	1144	" " " " " Roller (roller only).....
453c	1158	Needle Bar Connecting Stud Set Screw...
12384	1144	Needle Bar Connecting Stud complete, Nos. 453c, 1904 and 12383.....
20188	1142	Needle Bar Crank with 858c and 1065c..
1065c	7430	" " " " " Position Screw.....
858c	1158	" " " " " Set Screw.....
936E	1158	" " " " " Screw Bushing.....
4302	7428	" " " " " Thread Guide.....
233J	987	" " " " " Screw.....
4303	7428	" Clamp with 808F.....
808F	7430	" " " " " Screw.....
19386	1142	Oscillating Rock Shaft.....
19387	—	Oscillating Rock Shaft complete, Nos. 4784, 12388 and 19386.....
12388	1142	Oscillating Rock Shaft Hinge Pin.....
448c	1158	" " " " " " " Set Screw
4784	1150	" " " " " Oil Pad.....
21013	1141	" Shaft.....
20749	—	" " Crank.....
20750	7427	Oscillating Shaft Crank complete, Nos. 219c, 1518E, 19390 and 20749.....
2049	1150	Oscillating Shaft Crank Pin.....
219c	1157	" " " " " Set Screw.....
19389	1149	" " " " " Slide Block.....
226E	7438	" " " " " " " Cap Screw.....

From the library of: www.jamborg.com

NO.	PLATE	NAME
12424	1149	Oscillating Shaft Crank Slide Block Cap Screw Washer.....
969c	1149	Oscillating Shaft Crank Slide Block Screw Stud.....
1518E	1159	Oscillating Shaft Crank Slide Block Screw Stud Nut.....
19390	1149	Oscillating Shaft Crank Slide Block complete, Nos. 226E, 969c, 12424 and 19389
16045	1150	Oscillating Shaft (back bearing) Oil Tube
12391	1170	Presser Bar (hollow).....
12326	1145	" " Guide Bracket with 453c....
453c	1158	" " " " Set Screw....
2062	1145	" " Lifter.....
689c	1157	" " " Hinge Screw.....
1520E	1159	" " " " Nut.....
12327	1145	" " Lifting and Releasing Lever Bracket.....
11167	1142	Presser Bar Spring (light) .051 wire.....
12139	1142	" " " (medium) .055 wire....
20023	1142	" " " (heavy) .063 wire....
11170	1150	" " " Washer.....
20589	1193	" Foot for 20662 and 20685.....
20625	7426	" " " 20656 and 20664.....
190b	1157	" " Screw.....
NOTE: Presser Foot No. 20625 is sent with this Machine unless another Presser Foot is specified on order		
688J	1158	Pressure Regulating Thumb Screw.....
19131	5737	Shuttle Bobbin.....
20713	4320	" " Case Guide Plate.....
399J	4320	" " " " " Screw....
20650	—	" " " Hinge, Nos. 2973, 2974 and 20649.....
20649	5737	Shuttle Bobbin Case Latch.....
2973	5737	" " " " Lever.....
2974	5737	" " " " " Fulcrum Pin.....
2975	5737	Shuttle Bobbin Case Latch Spring.....
592E	5737	" " " " Stop Screw....
20755	5737	" " " Position Finger.....
2523	5737	" " " " Rivet.....
20756	5737	Shuttle Bobbin Case complete, Nos. 591E, 592E, 2523, 2975, 20650, 20654 and 20755.....

NO.	PLATE	NAME
20757	5737	Shuttle Body.....
591F	5737	" Tension Regulating Screw.....
20654	5737	" " Spring.....
20758	5737	Shuttle, 1 1/4 in. diam., Nos. 19131, 20756 and 20757.....
20621	7427	Shuttle Driver and Feed Lifting Eccentric
2049	1150	" " " " " " " " Pin.....
20716	—	Shuttle Race Body.....
20714	4320	" " Cap.....
934D	4320	" " " Screw.....
20718	7427	Shuttle Race complete (steel) Nos. 20713, 20714, 20716 and two each 399J and 934D.....
131E	1157	Shuttle Race Screw.....
2102	7428	Tension Disc.....
1560C	1146	" Regulating Thumb Nut.....
32572	7428	" Releasing Disc.....
43944	7428	" " Lever.....
12398	1145	" " " Hinge Pin.....
12329	1145	" " " Spring.....
32574	7428	" " Pin.....
50327C	7428	" Screw Stud.....
44111	—	" " " 50327c with 1560c.....
43945	7428	" Spring.....
12149	1150	" Thread Guard.....
210958	7428	Thread Retaining Collar.....
210993	7428	" " Sleeve.....
52398	7428	" " Spring.....
52378	7428	" " Stud.....
460C	1158	" " " Set Screw.....
52379	—	Thread Retainer complete, Nos. 52378, 52398, 210958 and 210993.....
12404	7428	Thread Take-up Crank.....
3094	1144	" " " Wedge.....
690E	1144	" " " " Screw.....
12408	7428	" " Lever.....
775E	1144	" " " Cap Screw.....
12166	1144	" " " Hinge Pin.....
12409	1144	" " " Link.....
11204	1144	" " " " Hinge Pin....
435c	7430	" " " " " " " " Set Screw.....
12410	—	Thread Take-up Lever complete, Nos. 12166, 12408 and 12409.....

From the library of: Diamond Needle Corp.

NO.	PLATE	NAME
19158	1150	Thread Take-up Spring.....
7336	1149	" " " Regulator.....
448c	1158	" " " " Set Screw
20657	1189	Throat Plate for 20656.....

NOTE: Throat Plate No. 20657 is sent with this machine, unless another Throat Plate is specified on order

20663	1190	Throat Plate for 20662.....
20665	1191	" " large needle hole, for 20664
20666	—	" " small needle hole, for 20664
20686	1193	" " for 20685.....
691F	1158	" " Screw.....
20561	1164	Drip Pan.....

Genuine Singer Needles and their Containers are marked with the Company's Trade Mark "SIMANCO." 1

Needles in Containers marked "For Singer Machines" are not Singer made needles. 2

LIST OF PARTS COMPLETE

FOR

MACHINE No. 57-4

FOR CLOTHING, ETC. ONE NEEDLE; HAS EXTENDED THROAT PLATE FOR USE WITH UNIVERSAL FELLING ATTACHMENT; DROP FEED UP THE ARM.

NO.	PLATE	NAME
*21022	—	Arm with 11104.....
8582	1150	" Dowel Pin.....
12453	1150	" Oil Tube for intermediate bearing...
12454	1150	" " " with 52045, for oiling 12409
11119	1150	" " " " 52045, for oiling 12408
20502	1150	" " " " 29599, for oiling 20197
29599	7429	" " " Packing (felt) for 20502...
52045	7438	" " " " (braided cotton)
		for 11119 and 12454.....
748E	1157	Arm Screw (back).....
868E	1157	" " (front).....
21002	1167	" Shaft.....
*11104	—	" " Bushing (front).....
12357	1142	" " Flanged Bushing (back).....
448c	1158	" " " " " Set Screw
21026	1166	" " Gear with 453c and 454c....
23724	7429	" " " Pin.....
453c	1158	" " " Position Screw.....
454c	1158	" " " Set Screw.....
144b	1157	" " Screw.....
12480	1143	" Side Cap.....
219j	1157	" " " Screw.....
12193	1143	" " Cover.....
286b	1158	" " " Thumb Screw.....
21004	1140	" " Wheel with two 450c.....
23724	7429	" " " Pin.....
450c	1158	" " " Set Screw.....
21005	1166	" " " Shaft.....
21006	1166	" " " " Collar with 449c..
23724	7429	" " " " " Pin.....
449c	1158	" " " " " Set Screw..
21027	1166	" " " " Gear with 453c and 454c.....
23724	7429	Arm Side Wheel Shaft Gear Pin.....
453c	1158	" " " " " Position Screw.....

From the Library of: Diamond Tools Corp.

NO.	PLATE	NAME
454c	1158	Arm Side Wheel Shaft Gear Set Screw...
21023	1170	" " " " " Cover.....
219J	1157	" " " " " " Screw
12403	1150	" Spool Pin and Thread Eyelet.....
11241	1142	" " " Washer (cloth).....
12358	1140	Balance Wheel (power) light rim, 2 $\frac{3}{8}$ in. pulley, with two 448c.....
448c	1158	Balance Wheel Set Screw.....
20197	1141	Crank Connecting Rod with 20198 and two 896E.....
*20198	—	Crank Connecting Rod Cap.....
896E	1157	" " " " Screw.....
908c	1158	" " " Hinge Screw.....
1619E	1159	" " " " " Nut.
*21024	—	Cylinder, 2 $\frac{7}{8}$ in. diam.....
21040	7425	" Cover.....
20505	1142	" Feed Cover.....
219J	1157	" " " Screw.....
12366	—	Face Plate.....
12367	1170	Face Plate complete, Nos. 2827, 12150 and 12366.....
190D	1157	Face Plate Screw.....
12150	7428	" " Thread Guard (lower) with 12152.....
12152	1150	Face Plate Thread Guard (lower) Rivet...
2827	7428	" " " " (upper) with 8505.....
8505	7428	Face Plate Thread Guard (upper) Rivet...
286D	1158	" " Thumb Screw.....
3033	1145	Feed Connecting Link.....
375c	1158	" " " Hinge Screw.....
1518E	1159	" " " " " Nut.
20685	1193	" Dog, 20 teeth (16 teeth to the inch)
704c	1157	" Screw.....
3074	1142	" Eccentric with 446c.....
446c	1158	" " Set Screw.....
20518	1141	" Forked Connection with 20519 and two 175E.....
*20519	—	Feed Forked Connection Cap.....
175E	1157	" " " " Screw.....
20520	1145	" Raising Fork.....
704c	1157	" " " Screw.....
20521	1142	" Regulator.....
1128E	7430	" " Hinge Screw.....
283D	7430	" " Thumb Screw.....
20522	1141	" Rock Shaft.....
20523	1141	" " " Arm with 460c.....

NO.	PLATE	NAME
2049	1150	Feed Rock Shaft Arm Pin.....
460c	1158	" " " " Set Screw.....
295c	1158	" " " Screw Center.....
1513J	1159	" " " " " Nut.....
21012	1141	" Rod.....
923E	1158	" " Hinge Screw.....
21041	1170	Needle Bar (hollow) with 857H.....
12382	1144	" " Connecting Link with 794E...
794E	1144	" " " " Adjusting Screw.....
*12383	—	Needle Bar Connecting Stud.....
1904	1144	" " " " Roller (roller only).....
453c	1158	Needle Bar Connecting Stud Set Screw...
12384	1144	Needle Bar Connecting Stud complete, Nos. 453c, 1904 and 12383.....
20188	1142	Needle Bar Crank with 858c and 1065c
1065c	7430	" " " Position Screw...
858c	1158	" " " Set Screw.....
936E	1158	" " Screw Bushing.....
857H	7430	" Set Screw.....
19386	1142	Oscillating Rock Shaft.....
19387	—	Oscillating Rock Shaft complete, Nos. 4784, 12388 and 19386.....
12388	1142	Oscillating Rock Shaft Hinge Pin.....
448c	1158	" " " " " Set Screw
4784	1150	" " " Oil Pad.....
21013	1141	" Shaft.....
19496	—	" " Crank.....
19388	1149	Oscillating Shaft Crank complete, Nos. 457c, 1518E, 19390 and 19496.....
2049	1150	Oscillating Shaft Crank Pin.....
457c	7430	" " " Set Screw.....
19389	1149	" " " Slide Block.....
226E	7438	" " " " " Cap Screw.....
12424	1149	Oscillating Shaft Crank Slide Block Cap Screw Washer.....
969c	1149	Oscillating Shaft Crank Slide Block Screw Stud.....
1518E	1159	Oscillating Shaft Crank Slide Block Screw Stud Nut.....
19390	1149	Oscillating Shaft Crank Slide Block com- plete, Nos. 226E, 969c, 12424 and 19389
16045	1150	Oscillating Shaft (back bearing) Oil Tube.

From the Library of Diamond Needle Corp.

NO.	PLATE	NAME
20563	1142	Presser Bar (hollow).....
21042	7428	“ “ Extension with two 202F.....
202F	7430	“ “ “ Clamping Screw.....
21043	7428	“ “ “ Foot Bar.....
12326	1145	“ “ Guide Bracket with 453c.....
453C	1158	“ “ “ “ Set Screw.....
2062	1145	“ “ Lifter.....
689C	1157	“ “ “ Hinge Screw.....
1520E	1159	“ “ “ “ Nut.....
12327	1145	“ “ Lifting and Releasing Lever Bracket.....
11167	1142	Presser Bar Spring (light) .051 wire.....
12139	1142	“ “ “ (medium) .055 wire.....
20023	1142	“ “ “ (heavy) .063 wire.....
11170	1150	“ “ “ Washer.....
7298	7429	“ Foot Hinge Pin.....
19334	—	“ “ Plate.....
19335	—	“ “ Shank.....
19336	7426	Presser Foot (hinged) complete, Nos. 7298, 19334 and 19335.....
190D	1157	Presser Foot Screw.....
688J	1158	Pressure Regulating Thumb Screw.....
19131	5737	Shuttle Bobbin.....
20713	4320	“ “ Case Guide Plate.....
399J	4320	“ “ “ “ “ Screw.....
20650	—	“ “ “ Hinge, Nos. 2973, 2974 and 20649.....
20649	5737	Shuttle Bobbin Case Latch.....
2973	5737	“ “ “ “ Lever.....
2974	5737	“ “ “ “ “ Fulerum Pin.....
2975	5737	Shuttle Bobbin Case Latch Spring.....
592E	5737	“ “ “ “ Stop Screw.....
20755	5737	“ “ “ Position Finger.....
2523	5737	“ “ “ “ “ Rivet.....
20756	5737	Shuttle Bobbin Case complete, Nos. 591F, 592E, 2523, 2975, 20650, 20654 and 20755.....
20757	5737	Shuttle Body.....
591F	5737	“ Tension Regulating Screw.....
20654	5737	“ “ Spring.....
20758	5737	“ 1 1/8 in. diam., Nos. 19131, 20756 and 20757.....
20621	7427	Shuttle Driver and Feed Lifting Eccentric
2049	1150	“ “ “ “ “ “ Pin.....

NO.	PLATE	NAME
20715	—	Shuttle Race Body.....
20714	4320	“ “ Cap.....
934D	4320	“ “ “ Screw.....
20717	4320	Shuttle Race complete (steel) Nos. 20713 to 20715 and two each 399J and 934D.....
131E	1157	Shuttle Race Screw.....
2102	7428	Tension Disc.....
1560C	1146	“ Regulating Thumb Nut.....
32572	7428	“ Releasing Disc.....
43944	7428	“ “ Lever.....
12398	1145	“ “ “ Hinge Pin.....
12329	1145	“ “ “ Spring.....
32574	7428	“ “ Pin.....
50327C	7428	“ Screw Stud.....
44141	—	“ “ 50327C with 1560C.....
43945	7428	“ Spring.....
12449	1150	“ Thread Guard.....
210958	7428	Thread Retaining Collar.....
210993	7428	“ “ Sleeve.....
52398	7428	“ “ Spring.....
52378	7428	“ “ Stud.....
460C	1158	“ “ “ Set Screw.....
52379	—	Thread Retainer complete, Nos. 52378, 52398, 210958 and 210993.....
12404	7428	Thread Take-up Crank.....
3094	1144	“ “ “ Wedge.....
690E	1144	“ “ “ “ Screw.....
12408	7428	“ “ Lever.....
775E	1144	“ “ “ Cap Screw.....
12166	1144	“ “ “ Hinge Pin.....
12409	1144	“ “ “ Link.....
11204	1144	“ “ “ “ Hinge Pin
435C	7430	“ “ “ “ “ “ Set Screw.....
12410	—	Thread Take-up Lever complete, Nos. 12166, 12408 and 12409.....
19158	1150	Thread Take-up Spring.....
7336	1149	“ “ “ Regulator.....
448C	1158	“ “ “ “ Set Screw
21044	7425	Throat Plate for 20685.....
691F	1158	“ “ Screw.....
20561	1164	Drip Pan.....

**LIST OF PARTS COMPLETE
FOR
MACHINE No. 57-14**

**FOR CLOTH; ONE NEEDLE; DROP FEED ACROSS THE
ARM; FEED AT LEFT OF NEEDLE**

NO.	PLATE	NAME
*12355	—	Arm with 11104.....
8582	1150	" Dowel Pin.....
12453	1150	" Oil Tube for intermediate bearing...
12454	1150	" " " with 52045, for oiling 12409
11119	1150	" " " " 52045, for oiling 12408
20502	1150	" " " " 29599, for oiling 20197
29599	7429	" " " Packing (felt) for 20502...
52045	7438	" " " " (braided cotton) for 11119 and 12454.....
748E	1157	Arm Screw (back).....
868E	1157	" " (front).....
12427	7434	" Shaft.....
*11104	—	" " Bushing (front).....
12357	1142	" " Flanged Bushing (back).....
448c	1158	" " " " " Set Screw.....
144D	1157	Arm Shaft Screw.....
12480	1143	" Side Cap.....
219J	1157	" " " Screw.....
12193	1143	" " Cover.....
286D	1158	" " " Thumb Screw.....
12403	1150	" Spool Pin and Thread Eyelet.....
11241	1142	" " " Washer (cloth).....
12358	1140	Balance Wheel, light rim, 2 7/8 in. pulley, with two 448c.....
448c	1158	Balance Wheel Set Screw.....
20564	7434	Cloth Plate.....
20565	—	Cloth Plate complete, Nos. 3286, 20564, 20568 and two 240J.....
20566	—	Cloth Plate with Bracket complete, Nos. 20565, 20567 and two 389F.....
20567	7435	Cloth Plate Bracket with 345C.....
545c	7437	" " " Set Screw
389F	7438	" " " Screw.....
20568	7435	" " Slide.....
3286	7437	" " " Spring.....
240J	7438	" " " " Screw.....
20197	1141	Crank Connecting Rod with 20198 and two 896E.....

NO.	PLATE	NAME
*20198	—	Crank Connecting Rod Cap.....
896E	1157	" " " " " Screw.....
908c	1158	" " " " " Hinge Screw.....
1619E	1159	" " " " " " Nut..
*21029	—	Cylinder, 2 7/8 in. diam.....
12366	—	Face Plate.....
12367	1170	Face Plate complete, Nos. 2827, 12150 and 12366.....
190D	1157	Face Plate Screw.....
12150	7428	" " " Thread (Guard (lower) with 12152.....
12152	1150	Face Plate Thread (Guard (lower) Rivet..
2827	7428	" " " " (upper) with 8505.....
8505	7428	Face Plate Thread (Guard (upper) Rivet..
286D	1158	" " " Thumb Screw.....
3032	7437	Feed Cam with 446c.....
446c	1158	" " " Set Screw.....
3033	1145	" Connecting Link.....
375c	1158	" " " " Hinge Screw.....
1518E	1159	" " " " " " Nut...
20573	7432	" Dog, 13 teeth (18 teeth to the inch) for shirt work.....
20577	7433	Feed Dog, 12 teeth (18 teeth to the inch) NOTE: Feed Dog No. 20577 is sent with this Machine, unless another Feed Dog is specified on order
20579	7432	Feed Dog, 13 teeth (18 teeth to the inch) for shirt work.....
20701	7437	Feed Dog Carrier.....
225c	7438	" " " Screw.....
20581	7435	" Forked Connection.....
375c	1158	" " " " Hinge Screw....
1518E	1159	" " " " " " Nut
20521	1142	" Regulator.....
1128E	7430	" " " Hinge Screw.....
283D	7430	" " " Thumb Screw.....
21030	7434	" Rock Shaft.....
20640	7437	" " " Oil Tube, for back bear- ing.....
20583	7436	Feed Rock Shaft Crank with 190D.....
156c	7438	" " " " " Position Screw...
190D	1157	" " " " " Set Screw.....
12381	1170	Needle Bar (hollow).....
12382	1144	" " " Connecting Link with 794E..
794E	1144	" " " " " Adjusting Screw.....

From the library of: Diamond Needle Corp.

NO.	PLATE	NAME
*12383	—	Needle Bar Connecting Stud
1904	1144	“ “ “ “ Roller (roller only)
453c	1158	Needle Bar Connecting Stud Set Screw
12384	1144	Needle Bar Connecting Stud complete, Nos. 453c, 1904 and 12383
20188	1142	Needle Bar Crank with 858c and 1065c
1065c	7430	“ “ “ Position Screw
858c	1158	“ “ “ Set Screw
936E	1158	“ “ Screw Bushing
4302	7428	“ “ Thread Guide
233J	987	“ “ “ Screw
4303	7428	“ Clamp with 808F
808F	7430	“ “ Screw
19386	1142	Oscillating Rock Shaft
19387	—	Oscillating Rock Shaft complete, Nos. 4784, 12388 and 19386
12388	1142	Oscillating Rock Shaft Hinge Pin
448c	1158	“ “ “ “ Set Screw
4784	1150	“ “ “ Oil Pad
21031	7435	“ Shaft
20749	—	“ Crank
20750	7427	Oscillating Shaft Crank complete, Nos. 219c, 1518E, 19390 and 20749
2049	1150	Oscillating Shaft Crank Pin
219c	1157	“ “ “ Set Screw
19389	1149	“ “ “ Slide Block
226E	7438	“ “ “ “ Cap Screw
12424	1149	Oscillating Shaft Crank Slide Block Cap Screw Washer
969c	1149	Oscillating Shaft Crank Slide Block Screw Stud
1518E	1159	Oscillating Shaft Crank Slide Block Screw Stud Nut
19390	1149	Oscillating Shaft Crank Slide Block complete, Nos. 226E, 969c, 12424 and 19389
16045	1150	Oscillating Shaft (back bearing) Oil Tube
12391	1170	Presser Bar (hollow)
12326	1145	“ “ Guide Bracket with 453c
453c	1158	“ “ “ “ Set Screw
2062	1145	“ “ Lifter
689c	1157	“ “ “ Hinge Screw
1520E	1159	“ “ “ “ Nut
12327	1145	“ “ Lifting and Releasing Lever Bracket

NO.	PLATE	NAME
11167	1142	Presser Bar Spring (light) .051 wire
12139	1142	“ “ “ (medium) .055 wire
20023	1142	“ “ “ (heavy) .063 wire
11170	1150	“ “ “ Washer
20587	7432	“ Foot (concave feed dog bearing) for 20577
NOTE: Presser Foot No. 20587 is sent with this Machine, unless another Presser Foot is specified on order		
20588	7432	Presser Foot (concave feed dog bearing) for 20573
190D	1157	Presser Foot Screw
688J	1158	Pressure Regulating Thumb Screw
19131	5737	Shuttle Bobbin
20650	—	“ “ Case Hinge, Nos. 2973, 2974 and 20649
20649	5737	Shuttle Bobbin Case Latch
2973	5737	“ “ “ “ Lever
2974	5737	“ “ “ “ “ Fulcrum Pin
2975	5737	Shuttle Bobbin Case Latch Spring
592E	5737	“ “ “ “ Stop Screw
20755	5737	“ “ “ Position Finger
2523	5737	“ “ “ “ Rivet
20756	5737	Shuttle Bobbin Case complete, Nos. 591E, 592E, 2523, 2975, 20650, 20654 and 20755
20757	5737	Shuttle Body
591F	5737	“ Tension Regulating Screw
20654	5737	“ “ Spring
20758	5737	Shuttle, 1 1/4 in. diam., Nos. 19131, 20756 and 20757
20697	7436	Shuttle Driver and Feed Lifting Cam
2019	1150	“ “ “ “ “ Pin
20659	7435	“ Race with 20700 and two 1053D
20700	7436	“ “ Cap
1053D	1177	“ “ “ Screw
20719	7437	“ “ Cover
937F	7438	“ “ “ Hinge Screw
127E	7438	“ “ “ Screw
2102	7428	Tension Disc
1560c	1146	“ Regulating Thumb Nut
32572	7428	“ Releasing Disc
43944	7428	“ “ Lever
12398	1145	“ “ “ Hinge Pin
12329	1145	“ “ “ Spring

NO.	PLATE	NAME
32574	7428	Tension Releasing Pin.....
50327c	7428	" Screw Stud.....
44141	—	" " " 50327c with 1560c...
43945	7428	" Spring.....
12149	1150	" Thread Guard.....
52454	7436	Thread Retainer.....
50429c	7438	" " Set Screw.....
12404	7428	" Take-up Crank.....
3094	1144	" " " Wedge.....
690E	1144	" " " " Screw.....
12408	7428	" " Lever.....
775E	1144	" " " Cap Screw.....
12166	1144	" " " Hinge Pin.....
12409	1144	" " " Link.....
11204	1144	" " " " Hinge Pin ..
12410	—	Thread Take-up Lever complete, Nos. 12166, 12408 and 12409.....
435c	7430	Thread Take-up Lever Link Hinge Pin Set Screw.....
8511	7436	Thread Take-up Spring.....
7336	1149	" " " Regulator.....
448c	1158	" " " " Set Screw
20698	—	Throat Plate, large needle hole, for 20573
20699	7432	" " small needle hole, for 20573
20708	—	" " large needle hole, for 20577
20709	7433	" " small needle hole, for 20577

NOTE: Throat Plate No. 20709 is sent with this
Machine, unless another Throat Plate
is specified on order

20748	7432	Throat Plate for 20579.....
691F	1158	" " Screw.....
20561	1164	Drip Pan.....

IRON BASE

NO.	PLATE	NAME
20747	4321	Machine Base with four each 121E and wood screws 1 1/4 in. No. 12.....
121E	7430	Machine Base Screw to secure machine to base.....

ATTACHMENTS AND ACCESSORIES

NO.	PLATE	NAME
51077E	7438	Bolt with 51581E, to secure machine to table.....
51581E	7438	Bolt Nut.....

NO.	PLATE	NAME
6055	1145	Bolt Nut Washer.....
120346	1161	Oiler (copper plated) with 120347.....
120347	1161	" Spout, 9 in. long.....
26026	1161	Screw Driver (machine).....
26485	1161	" " (shuttle tension).....
20535	1149	Shuttle Bobbin Case Extractor.....
120341	1161	Tweezers (curved).....
4347	1161	Wrench for 1513 and 1518.....
8908	1161	" " 1520.....
19221	1161	" " 936 and 1619.....

LAP SEAM FELLER PARTS

FOR MACHINE No. 57-2

NO.	PLATE	NAME
20562	1143	Cylinder Cover for 26277.....
20508	1152	Feed Dog, 13 teeth (12 teeth to the inch) for 3/2 in. to 5/2 in. gauges.....
20515	1152	Feed Dog, 23 teeth (22 teeth to the inch) for 3/2 in. to 5/2 in. gauges.....
20510	1152	Feed Dog, 13 teeth (12 teeth to the inch) for 3/2 in. to 5/2 in. gauges (spiked teeth) for heavy work on duck, overalls, etc....
20509	1153	Feed Dog, 13 teeth (12 teeth to the inch) for 1 1/4 in. to 1 5/8 in. gauges.....
20511	1153	Feed Dog, 13 teeth (12 teeth to the inch) for 1 1/4 in. to 1 5/8 in. gauges (spiked teeth) for heavy work on duck, overalls, etc....
20507	1151	Feed Dog, 16 teeth (12 teeth to the inch) for 1/4 in. to 5/8 in. gauges.....
20514	1175	Feed Dog, 21 teeth (16 teeth to the inch) for 1/4 in. to 5/8 in. gauges.....
20512	1151	Feed Dog, 16 teeth (12 teeth to the inch) for 1/4 in. to 5/8 in. gauges (spiked teeth) for heavy work on duck, overalls, etc....
*26352	—	Folder for 26353.....
20636	—	" Slide with 10165.....
19294	1153	" " Spring.....
405E	1158	" " " Screw.....
10165	1150	" " Stop Pin.....
26277	1153	Holder (adjustable).....
922D	1158	" Thumb Screw.....
26353	1155	Lap Seam Feller (right hand) complete, for gauges 3/2 in. to 5/8 in. for light, me- dium, heavy, X-heavy, XX-heavy and XXX-heavy material, Nos. 20636 and 26352.....

NO.	PLATE	NAME
*26389	—	Folder.....
26390	1155	Lap Seam Feller (left hand) complete, for gauges $\frac{3}{8}$ in. to $\frac{5}{8}$ in., for light, medium, heavy, X-heavy, XX-heavy and XXX-heavy material, Nos. 20636 and 26389.....
*26391	—	Folder.....
26392	1155	Lap Seam Feller (right hand) complete, to fold top only, Nos. 20636 and 26391.....
*26393	—	Lap Seam Guide.....
26394	1156	Lap Seam Guide complete, Nos. 20636 and 26393.....
330J	1158	Presser Foot Clamping Screw.....
20530	1150	" " Hinge Pin.....
20637	—	" " Plate.....
21016	—	" " Shank.....
20638	1152	Presser Foot (hinged) complete, Nos. 330J, 20530, 20637 and 21016.....
330J	1158	Presser Foot Clamping Screw.....
20530	1150	" " Hinge Pin.....
20680	—	" " Plate.....
20681	—	" " Shank.....
20682	1156	Presser Foot (hinged) complete, hollowed across bottom between needle holes and heel, for riding seams, Nos. 330J, 20530, 20680 and 20681.....
330J	1158	Presser Foot Clamping Screw.....
18055	7429	" " Hinge Pin.....
20759	—	" " Plate.....
20760	—	" " Shank.....
35250	7429	" " Spring.....
20761	1171	Presser Foot (spring hinged) complete, Nos. 330J, 18055, 20759, 20760 and 35250.....
20550	1153	Throat Plate for 20509 and 20511.....
20549	1152	" " " 20508, 20510 and 20515.....
20555	—	" " large needle hole, for 20507, 20512 and 20514.....
20548	1151	Throat Plate, small needle hole, for 20507, 20512 and 20514.....
20687	—	Throat Plate Body.....
20688	1177	" " Needle Hole Strip.....
1053D	1177	" " " " Screw.....
20556	1177	Throat Plate complete for 20509 and 20511, Nos. 20687, 20688 and two 1053D.....

SHIRT CLOSING PARTS

FOR MACHINE No. 57-2

NO.	PLATE	NAME
20630	1179	Feed Dog, 22 teeth (16 teeth to the inch) $\frac{1}{8}$ in. to $\frac{3}{32}$ in. gauges.....
20631	987	Feed Dog, 22 teeth (16 teeth to the inch) $\frac{1}{8}$ in. to $\frac{3}{16}$ in. gauges.....
26337	987	Hemmer (foot) for felling.....
26338	987	" Bracket with two 211F.....
211F	987	" " Clamping Screw.....
6267	987	" Folder.....
25888	987	" Tongue.....
20632	1179	Throat Plate with 2653, for 20630 and 26339.....
20633	987	Throat Plate with 2653, for 20631 and 26339.....
26051	987	Throat Plate Cloth Guide.....
102D	987	" " " " Screw.....
1530E	987	" " " " " Nut.....
2653	987	" " " " Stop Pin.....
26339	987	" " Spring Guide.....
233J	987	" " " " Screw.....

STAYING PARTS

FOR MACHINE No. 57-2

NO.	PLATE	NAME
20513	1154	Feed Dog, 21 teeth (16 teeth to the inch) for $\frac{3}{8}$ in. to $\frac{5}{8}$ in. gauges.....
330J	1158	Presser Foot Clamping Screw.....
20530	1150	" " Hinge Pin.....
20642	—	" " Plate.....
21016	—	" " Shank.....
20643	1154	Presser Foot (hinged) complete, for inside stays, for 20551, Nos. 330J, 20530, 20642 and 21016.....
26384	1155	Stay Guide (lower).....
26385	1155	" " (upper).....
26386	—	Stay Guide complete, Nos. 26384 and 26385.....
337F	1158	Stay Guide Screw.....
20551	1154	Throat Plate for 20513.....
20557	1178	" " with 4515, for 20513.....
4515	—	" " Spring Guide.....

From the library of: Diamond Needle Corp

BOBBIN WINDER

(SWINGING AUTOMATIC, RIGHT HAND)

NO.	PLATE	NAME
27552	1162	Base.....
15072	1150	Bobbin Position Pin.....
27302	1162	Frame.....
50356D	7430	" Hinge Screw.....
1620J	7430	" " " Nut.....
27303	1150	" Spring.....
27553	1162	Pulley.....
27849	—	Spindle.....
27538	1162	" 27849 with 15072, 27850 and 41828
27850	—	" Collar.....
41828	—	" " Pin.....
27306	1162	Spool Pin.....
27307	1162	" Stand.....
27308	1162	Spool Stand complete, Nos. 418E, 1562J, 2106, 10141, 11241, 27306, 27307 and two each 2455 and wood screws 1 in. No. 10.....
11241	1142	Spool Pin Washer (cloth).....
27587	1162	Stop Latch.....
35D	1157	" " Hinge Screw.....
2455	1150	Tension Disc.....
1562J	1159	" Regulating Thumb Nut.....
418E	1158	" Screw Stud.....
10141	1150	" Spring.....
2106	1150	" Thread Guide.....
27651	1162	Bobbin Winder, Nos. 35D, 1620J, 27302, 27303, 27538, 27552, 27553, 27587, 50356D and two wood screws 1 in. No. 7
27588	—	Bobbin Winder (swinging automatic, right hand) complete, Nos. 27308 and 27651

DRIVING ATTACHMENT

NO.	PLATE	NAME
16592	1167	Balance Wheel (friction) with 7958, 16524 and two 435c.....
16524	—	Balance Wheel Friction Ring (leather)...
7958	1150	" " " " Stop Pin...
24355	1170	" " Oil Cover.....
210D	7430	" " " Screw.....
435c	7430	" " Set Screw.....
20667	4314	Driving Arm with 2928 and two 15132...
341D	7430	" " Adjusting Screw.....
1594c	7430	" " " " Nut.....

NO.	PLATE	NAME
20668	4314	Driving Arm Bracket.....
692D	7430	" " " Screw.....
2928	7429	" " Brake (leather).....
15132	7429	" " " Rivet.....
12178	7429	" " Friction Plug (wood).....
427E	1158	" " " " Adjusting Screw.....
1508c	1159	Driving Arm Friction Plug Adjusting Screw Nut.....
20677	7429	Driving Arm Pin.....
20669	4314	" " Shaft.....
20670	—	Driving Arm complete, Nos. 341D, 427E, 1508c, 1594c, 12178, 20667 to 20669, 20671, 20672, 20675, 20678 and two 20677.....
16594	1167	Driving Friction Pulley, 2 $\frac{1}{8}$ in. diam. with 861D and 10236.....
10236	7429	Driving Friction Pulley Center Bearing.....
861D	7430	" " " Oil Hole Plug Screw.....
2763	4321	Rock Shaft.....
27683	4321	" " Arm with two 356c.....
356c	1157	" " " Set Screw.....
2764	4321	" " Hanger with two wood screws 1 in. No. 10.....
20673	4321	Rock Shaft complete, Nos. 2763 and two each 2764 and 27683.....
27072	7431	Shaft Driving Pulley (sectional, grooved) 12 in. diam., 1 $\frac{3}{8}$ in. bore, with two 597c
597c	1157	Shaft Driving Pulley Clamping Screw.....
20671	4314	Starting Crank.....
20674	4314	" " Connecting Rod.....
20675	7429	" " " " Joint.....
20678	7429	" " " " " Hinge Stud.....
1620E	7430	Starting Crank Connecting Rod Lock Nut
20677	7429	" " Pin.....
20672	4314	" " Spring.....
14229	4321	Table Belt Guide Bracket with 448c.....
14230	4321	" " " Pulley.....
126928	—	" " " " Shaft.....
14231	1170	" " " " " 126928 with 858c.....
858c	1158	Table Belt Guide Pulley Shaft Plug Screw
448c	1158	" " " " " Set Screw
14232	4321	Table Belt Guide complete, Nos. 14229 to 14231 and four R. H. M. F. O. and A. wood screws 1 $\frac{1}{4}$ in. No. 10.....

From the library of: Diamond Needle Corp

NO.	PLATE	NAME
126036	3477	Treadle.....
126205	7435	" Bracket (left).....
126207	7438	" " " Hook.....
23258	7438	" " " " Friction Washer.....
126208	7438	" " " " Rivet.....
126206	—	Treadle Bracket (left) complete, Nos. 23258, 126205, 126207, 126208 and two wood screws 1 in. No. 14.....
46681	7435	Treadle Bracket (right).....
60502	—	" " " 46681 with two wood screws 1 in. No. 14.....
27637	1164	Treadle Pitman Rod (lower).....
27638	1164	" " " " Spring.....
27639	1164	" " " (upper).....
9079	1164	" " " Clamp with 351c.....
354c	1157	" " " " Screw.....
6055	1145	" " " Washer.....
27640	1164	Treadle Pitman complete, Nos. 2762, 6055, 27637 to 27639 and two 9079.....
2762	1164	Treadle Stop Collar with 362F.....
362F	1157	" " " Set Screw.....
126209	—	Treadle complete, Nos. 60502, 126036 and 126206.....
126210	—	Treadle and Pitman complete, Nos. 27640 and 126209.....
20676	—	Driving Attachment with Rock Shaft and Treadle complete, Nos. 210b, 692d, 1620E, 16592, 16594, 20670, 20673, 20674, 24355, 27072, 126210 and two 14232.....

FOOT LIFTER PARTS

NO.	PLATE	NAME
13351	—	Chain, 46 in. to 55 in. long, with 56864 and 56865.....

NOTE: When ordering 13351, give length required

56864	7438	Chain Hook (large).....
56865	7438	" " (small).....
12237	4321	Lifting Lever with 448c.....
802d	1157	" " Hinge Screw.....
12241	1145	" " Link.....
766d	1157	" " " Hinge Screw.....
12240	1145	" " Pin.....
448c	1158	" " " Set Screw.....
20559	1140	" " Spring.....

NO.	PLATE	NAME
20558	1140	Pitman, 13 in. long.....
12416	1145	" Joint.....
76d	1157	" " Hinge Screw.....
1521E	1159	" Lock Nut.....
14209	3477	Treadle.....
7585	1140	" Shaft.....
14357	3477	" Stand.....
14358	3477	Treadle complete, Nos. 7585, 14209, 14357 and two wood screws 1¼ in. No. 12...
21028	—	Foot Lifter complete, Nos. 76d, 766d, 802d, 1521E, 12237, 12240, 12241, 12416, 13351, 14358, 20558 and 20559.....

KNEE LIFTER PARTS

NO.	PLATE	NAME
12237	4321	Lifting Lever with 448c.....
802d	1157	" " Hinge Screw.....
12241	1145	" " Link.....
766d	1157	" " " Hinge Screw.....
12240	1145	" " Pin.....
448c	1158	" " Set Screw.....
20559	1140	" " Spring.....
20558	1140	Pitman, 13 in. long.....
12416	1145	" Joint.....
76d	1157	" " Hinge Screw.....
1521E	1159	" Lock Nut.....
7124	1167	Rock Shaft.....
2764	1167	" " Hanger (back) with two wood screws 1 in. No. 10.....
16128	1167	Rock Shaft Hanger (front) with two wood screws 1 in. No. 10.....
16646	1167	Rock Shaft Knee Arm.....
16647	—	Rock Shaft Knee Arm complete, Nos. 2766, 2767 and 16646.....
2766	1167	Rock Shaft Knee Arm Hub with 356c.....
356c	1157	" " " " " Set Screw....
2767	1167	" " " Plate with 356c.....
356c	1157	" " " " " Set Screw.....
6337	1167	" " Lifting Bracket with two 356c.....
6338	1167	" " " " Hook.....
356c	1157	" " " " " Set Screw.....
356c	1157	" " " " " Set Screw....
2770	1167	" " Stop Dog with 356c.....
356c	1157	" " " " " Set Screw.....
16129	1167	Rock Shaft complete, Nos. 2764, 6337, 6338, 7124, 16128, 16647 and two 2770.....

NO.	PLATE	NAME
21032	—	Knee Lifter complete, Nos. 76d, 766d, 802d, 1521E, 12237, 12240, 12241, 12416, 16129, 20558 and 20559.....

THREAD UNWINDER

FOR ONE SPOOL

NO.	PLATE	NAME
225389	8523	Spool Rest with 201018c.....
225388	8523	" " Rod.....
200383c	7438	" " Set Screw.....
201018c	7438	" " Set Screw.....
202490	8523	" Stand with 200383c.....
225391	8523	Thread Guide.....
201696j	7438	" " Lock Nut.....
225392	8523	" " Rod with 208E and 225393
208E	7430	" " Screw.....
225393	7438	" " Washer.....
225394	8523	Thread Unwinder complete, Nos. 201696j, 202490, 225388, 225389, 225391, 225392 and three wood screws $\frac{1}{8}$ in. No. 12....
27739	7234	Thread Cone (wood) for large cones.....
225390	7234	" " Holder, for inverted cones..

NOTE: Nos. 27739 and 225390 are used with, but not included in 225394

THREAD UNWINDER

FOR TWO SPOOLS

NO.	PLATE	NAME
225395	7233	Spool Rest with 201018c.....
225388	7233	" " Rod.....
200383c	7438	" " Set Screw.....
201018c	7438	" " Set Screw.....
202490	7233	" Stand with 200383c.....
225391	7233	Thread Guide.....
201696j	7438	" " Lock Nut.....
225392	7233	" " Rod with 208E and 225393
208E	7430	" " Screw.....
225393	7438	" " Washer.....
225396	7233	Thread Unwinder complete, Nos. 201696j, 202490, 225388, 225392, 225395, two 225391 and three wood screws $\frac{1}{8}$ in. No. 12.....
27739	7234	Thread Cone (wood) for large cones.....
225390	7234	" " Holder, for inverted cones..

NOTE: Nos. 27739 and 225390 are used with, but not included in 225396

OBSOLETE PARTS

NO.	PLATE	NAME
21003	1166	Arm Shaft Gear with 453c and 454c.....
21007	1166	" Side Wheel Shaft Gear with 453c and 454c.....
58E	1157	Feed Regulator Hinge Screw.....
818D	1158	" " Thumb Screw.....
19166	1142	Oscillating Rock Shaft.....
19167	—	" " " 19166 with 12388
12443	1160	" " " Oil Pad.....
16508	1160	" " " " " Holder with 12443.....
12390	1160	Oscillating Shaft Crank complete, Nos. 457c, 1518E, 1902 and 19496.....
1902	1160	Oscillating Shaft Crank Roller and Screw Stud.....
20526	1142	Presser Bar.....
20530	1150	" Foot Hinge Pin.....
20529	—	" " Plate.....
20528	—	" " Shank.....
20527	1156	" " (hinged) Nos. 20528 to 20530
2102	7428	Tension (upper) Disc.....
637c	7430	" " Screw Stud.....
8238	7429	" " Spring.....
19153	1160	Tension (upper) complete, Nos. 19151, two each 637c, 1547d, 1560c, 8238 and four 2102.....
19152	1160	Tension Plate Stud.....
19151	1160	" " for upper tension with 19152
12404	7428	Thread Take-up Crank for 57-2 Machine

Genuine Singer Needles and their Containers are marked with the Company's Trade Mark "SIMANCO." 1

Needles in Containers marked "For Singer Machines" are not Singer made needles. 2

**NUMERICAL LIST OF PARTS
FOR
MACHINES**

Nos. 57-2 to 57-4 and 57-14

From the library of: Diamond Needle Corp

NUMERICAL LIST OF PARTS

NO.	PLATE	NAME
35D	1157	Bobbin Winder Stop Latch Hinge Screw for 27651.....
58E	1157	Feed Regulator Hinge Screw, obsolete....
76D	1157	Pitman Joint Hinge Screw for 21028 and 21032.....
102D	987	Throat Plate Cloth Guide Screw for 26054
121E	7430	Machine Base Screw, to secure machine to base, for 20747.....
127E	7438	Shuttle Race Screw for 57-14 Machine....
131E	1157	" " " " 57-2 to 57-4 Machines.....
134D	1157	Tension Plate Screw for 57-2 Machine....
144D	1157	Arm Shaft Screw.....
145D	7430	" Spool Bracket Screw for 57-2 Machine.....
156C	7438	Feed Rock Shaft Crank Position Screw for 57-14 Machine.....
157E	1157	Feed Raising Fork Screw for 57-2 Machine
175E	1157	" Forked Connection Cap Screw for 20518.....
190D	1157	Face Plate Screw.....
190D	1157	Feed Rock Shaft Crank Set Screw for 20583.....
190D	1157	Presser Foot Screw for 57-3, 57-4 and 57-14 Machines.....
190D	1157	Shuttle (outside) Bobbin Case Position Plate Screw for 20543.....
202F	7430	Presser Bar Extension Clamping Screw for 21042.....
208E	7430	Thread Unwinder Thread Guide Rod Screw for 225392.....
209F	1157	Needle Set Screw for 20524.....
210D	7430	Driving Attachment Balance Wheel Oil Cover Screw for 20676.....
211F	987	Hemmer Bracket Clamping Screw for 26338.....
219C	1157	Oscillating Shaft Crank Set Screw for 20750.....
219J	1157	Arm Side Cap Screw.....
219J	1157	" " Wheel Shaft Gear Cover Screw for 57-2 and 57-4 Machines.....
219J	1157	Cylinder Feed Cover Screw for 57-2 to 57-4 Machines.....
225C	7438	Feed Dog Screw for 57-14 Machine.....

NO.	PLATE	NAME
226E	7438	Oscillating Shaft Crank Slide Block Cap Screw for 19390.....
233J	987	Needle Bar Thread Guide Screw for 57-3 and 57-14 Machines.....
233J	987	Throat Plate Spring Guide Screw for 26339
240J	7438	Cloth Plate Slide Spring Screw for 20565
283D	7430	Feed Regulator Thumb Screw.....
286D	1158	Arm Side Cover Thumb Screw.....
286D	1158	Face Plate Thumb Screw.....
295C	1158	Feed Rock Shaft Screw Center for 57-2 to 57-4 Machines.....
330J	1158	Presser Foot Clamping Screw for 20638, 20643, 20646, 20648, 20682, 20711, 20712, 20754, 20761, 20777, 21014 and 21017.....
337F	1158	Stay Guide Screw for 26386.....
341D	7430	Driving Attachment Driving Arm Adjusting Screw for 20670.....
345C	7437	Cloth Plate Bracket Set Screw for 20567..
354C	1157	Driving Attachment Treadle Pitman Rod Clamp Screw for 9079.....
356C	1157	Driving Attachment Rock Shaft Arm Set Screw for 27683.....
356C	1157	Rock Shaft Knee Arm Hub Set Screw for 2766.....
356C	1157	Rock Shaft Knee Plate Set Screw for 2767
356C	1157	“ “ Lifting Bracket Hook Set Screw for 6337.....
356C	1157	Rock Shaft Lifting Bracket Set Screw for 6337.....
356C	1157	Rock Shaft Stop Dog Set Screw for 2770..
362F	1157	Driving Attachment Treadle Stop Collar Set Screw for 2762.....
375C	1158	Feed Connecting Link Hinge Screw.....
375C	1158	“ Forked Connection Hinge Screw for 57-14 Machine.....
389F	7438	Cloth Plate Screw for 20566.....
399J	4320	Shuttle Bobbin Case Guide Plate Screw for 20717 and 20718.....
405E	1158	Lap Seam Feller Folder Slide Spring Screw for 57-2 Machine.....
418E	1158	Bobbin Winder Tension Screw Stud for 27308.....
427E	1158	Driving Attachment Driving Arm Friction Plug Adjusting Screw for 20670.....
430C	1144	Thread Take-up Lever Link Hinge Pin Set Screw for 57-2 Machine.....

NO.	PLATE	NAME
435C	7430	Driving Attachment Balance Wheel Set Screw for 16592.....
435C	7430	Thread Take-up Lever Link Hinge Pin Set Screw for 57-3, 57-4 and 57-14 Machines
446C	1158	Feed Eccentric Set Screw for 3074.....
446C	1158	“ Cam Set Screw for 3032.....
448C	1158	Arm Shaft Flanged Bushing (back) Set Screw.....
448C	1158	Balance Wheel Set Screw for 12358.....
448C	1158	Driving Attachment Table Belt Guide Pulley Shaft Set Screw for 14229.....
448C	1158	Lifting Lever Pin Set Screw for 12237....
448C	1158	Oscillating Rock Shaft Hinge Pin Set Screw.....
448C	1158	Thread Take-up Spring Regulator Set Screw.....
449C	1158	Arm Side Wheel Shaft Collar Set Screw for 21006.....
450C	1158	Arm Side Wheel Set Screw for 21004.....
453C	1158	“ Shaft Gear Position Screw for 21003 and 21026.....
453C	1158	Arm Side Wheel Shaft Gear Position Screw for 21007 and 21027.....
453C	1158	Needle Bar Connecting Stud Set Screw for 12384.....
453C	1158	Presser Bar Guide Bracket Set Screw for 12326.....
454C	1158	Arm Shaft Gear Set Screw for 21003 and 21026.....
454C	1158	Arm Side Wheel Shaft Gear Set Screw for 21007 and 21027.....
457C	7430	Oscillating Shaft Crank Set Screw for 12390 and 19388.....
460C	1158	Feed Rock Shaft Arm Set Screw for 20523
460C	1158	Thread Retainer Set Screw for 21009.....
460C	1158	“ Retaining Stud Set Screw for 57-3 and 57-4 Machines.....
591F	5737	Shuttle Tension Regulating Screw for 20756.....
591F	1148	Shuttle (inside) Tension Regulating Screw for 20533.....
591F	1148	Shuttle (outside) Tension Regulating Screw for 20534.....
592E	5737	Shuttle Bobbin Case Latch Stop Screw for 20756.....
592E	1148	Shuttle (inside) Bobbin Case Latch and Position Finger Stop Screw for 20533..

NO.	PLATE	NAME
592E	1148	Shuttle (outside) Bobbin Case Latch and Position Finger Stop Screw for 20534...
597c	1157	Driving Attachment Shaft Driving Pulley Clamping Screw for 27072.....
637c	7430	Tension (upper) Screw Stud for 19153, obsolete.....
662d	1158	Shuttle Race Loop Separator Screw for 20543.....
688j	1158	Pressure Regulating Thumb Screw.....
689c	1157	Presser Bar Lifter Hinge Screw.....
690E	1144	Thread Take-up Crank Wedge Screw....
691F	1158	Throat Plate Screw.....
692d	7430	Driving Attachment Driving Arm Bracket Screw for 20676.....
704c	1157	Feed Dog Screw for 57-2 to 57-4 Machines
704c	1157	“ Raising Fork Screw for 57-3 and 57-4 Machines.....
748E	1157	Arm Screw (back).....
766d	1157	Lifting Lever Link Hinge Screw for 21028 and 21032.....
775E	1144	Thread Take-up Lever Cap Screw.....
794E	1144	Needle Bar Connecting Link Adjusting Screw for 12382.....
802D	1157	Lifting Lever Hinge Screw for 21028 and 21032.....
808F	7430	Needle Clamp Screw for 4303.....
818d	1158	Feed Regulator Thumb Screw, obsolete..
854E	1159	Arm Screw (front) for 57-2 Machine....
857H	7430	Needle Set Screw for 21041.....
858c	1158	Driving Attachment Table Belt Guide Pulley Shaft Plug Screw for 14231.....
858c	1158	Needle Bar Crank Set Screw for 20188... .
861D	7430	Driving Attachment Driving Friction Pulley Oil Hole Plug Screw for 16594...
868E	1157	Arm Screw (front) for 57-3, 57-4 and 57-14 Machines.....
896E	1157	Crank Connecting Rod Cap Screw for 20197.....
905D	1157	Thread Guide Screw for 19162.....
908c	1158	Crank Connecting Rod Hinge Screw.....
916c	1146	Tension Screw Stud for 44209.....
922d	1158	Lap Seam Feller Holder Thumb Screw for 57-2 Machine.....
923E	1158	Feed Rod Hinge Screw for 57-2 to 57-4 Machines.....
934D	4320	Shuttle Race Cap Screw for 20717 and 20718.....

NO.	PLATE	NAME
935E	1157	Shuttle (inside) Bobbin Case Position Plate Screw for 20543.....
936E	1158	Needle Bar Screw Bushing.....
937F	7438	Shuttle Race Cover Hinge Screw for 57-14 Machine.....
969c	1149	Oscillating Shaft Crank Slide Block Screw Stud for 19390.....
1053D	1177	Shuttle Race Cap Screw for 20659.....
1053D	1177	Throat Plate Needle Hole Strip Screw for 20556.....
1065c	7430	Needle Bar Crank Position Screw for 20188.....
1128E	7430	Feed Regulator Hinge Screw.....
1508c	1159	Driving Attachment Driving Arm Friction Plug Adjusting Screw Nut for 20670... .
1513J	1159	Feed Rock Shaft Screw Center Nut for 57-2 to 57-4 Machines.....
1518E	1159	Feed Connecting Link Hinge Screw Nut..
1518E	1159	“ Forked Connection Hinge Screw Nut for 57-14 Machine.....
1518E	1159	Oscillating Shaft Crank Slide Block Screw Stud Nut for 12390, 19388 and 20750..
1520E	1159	Presser Bar Lifter Hinge Screw Nut.....
1521E	1159	Pitman Lock Nut for 21028 and 21032... .
1530E	987	Throat Plate Cloth Guide Screw Nut for 102.....
1547D	1146	Tension Screw Stud Nut for 19153 and 19195.....
1560c	1146	Tension Regulating Thumb Nut for 19153, 44141 and 44209.....
1562J	1159	Bobbin Winder Tension Regulating Thumb Nut for 27308.....
1594c	7430	Driving Attachment Driving Arm Adjusting Screw Nut for 20670.....
1619E	1159	Crank Connecting Rod Hinge Screw Nut
1620J	7430	Bobbin Winder Frame Hinge Screw Nut for 27651.....
1620E	7430	Driving Attachment Starting Crank Connecting Rod Lock Nut for 20676.....
1902	1160	Oscillating Shaft Crank Roller and Screw Stud for 12390, obsolete.....
1904	1144	Needle Bar Connecting Stud Roller (roller only) for 12384.....
2049	1150	Feed Rock Shaft Arm Pin for 57-2 to 57-4 Machines.....
2049	1150	Oscillating Shaft Crank Pin.....
2049	1150	Shuttle Driver and Feed Lifting Cam Pin for 57-14 Machine.....

NO.	PLATE	NAME
2049	1150	Shuttle Driver and Feed Lifting Eccentric Pin for all machines except 57-14.....
2062	1145	Presser Bar Lifter.....
2102	7428	Tension Disc for 57-3, 57-4 and 57-14 Machines.....
2102	7428	Tension (upper) Disc for 19153, obsolete..
2106	1150	Bobbin Winder Tension Thread Guide for 27308.....
2269	1146	Tension Releasing Lever (intermediate) Hinge Pin for 19195.....
2273	1150	Needle Clamp Pin for 57-2 Machine.....
2415	1140	Arm Spool Bracket for 15063.....
2455	1150	Bobbin Winder Tension Disc for 27308...
2521	1148	Shuttle (inside) Bobbin Case Latch and Position Finger Spring for 20533.....
2521	1148	Shuttle (outside) Bobbin Case Latch and Position Finger Spring for 20534.....
2523	5737	Shuttle Bobbin Case Position Finger Rivet for 20756.....
2653	987	Throat Plate Cloth Guide Stop Pin for 20632 and 20633.....
2762	1164	Driving Attachment Treadle Stop Collar with 362F, for 27640.....
2763	4321	Driving Attachment Rock Shaft for 20673
2764	4321	" " " " Hanger with two wood screws 1 in. No. 10, for 20673.....
2764	1167	Rock Shaft Hanger (back) with two wood screws 1 in. No. 10, for 16129.....
2766	1167	Rock Shaft Knee Arm Hub with 356c, for 16647.....
2767	1167	Rock Shaft Knee Plate with 356c, for 16647.....
2770	1167	Rock Shaft Stop Dog with 356c, for 16129
2827	7428	Face Plate Thread Guard (upper) with 8505, for 12367.....
2921	1146	Tension Disc for 19195.....
2923	1146	" Spring for 19195.....
2928	7429	Driving Attachment Driving Arm Brake (leather) for 20667.....
2973	5737	Shuttle Bobbin Case Latch Lever for 20650.....
2974	5737	Shuttle Bobbin Case Latch Lever Fulcrum Pin for 20650.....
2975	5737	Shuttle Bobbin Case Latch Spring for 20756.....
3032	7437	Feed Cam with 446c, for 57-14 Machine..

NO.	PLATE	NAME
3033	1145	Feed Connecting Link.....
3074	1142	" Eccentric with 446c, for 57-2 to 57-4 Machines.....
3094	1144	Thread Take-up Crank Wedge.....
3286	7437	Cloth Plate Slide Spring for 20565.....
4302	7428	Needle Bar Thread Guide for 57-3 and 57-14 Machines.....
4303	7428	Needle Clamp with 808F, for 57-3 and 57-14 Machines.....
4347	1161	Wrench for 1513 and 1518 (Attachments and Accessories).....
4515	—	Throat Plate Spring Guide for 20557.....
4784	1150	Oscillating Rock Shaft Oil Pad for 19387..
6055	1145	Bolt Nut Washer (Attachments and Accessories).....
6055	1145	Driving Attachment Treadle Pitman Rod Washer for 27640.....
6267	987	Hemmer Folder, for shirt closing, for 57-2 Machine.....
6337	1167	Rock Shaft Lifting Bracket with two 356c, for 16129.....
6338	1167	Rock Shaft Lifting Bracket Hook for 16129.....
7124	1167	Rock Shaft for 16129.....
7298	7429	Presser Foot Hinge Pin for 19336.....
7336	1149	Thread Take-up Spring Regulator.....
7585	1140	Treadle Shaft for 14358.....
7958	1150	Driving Attachment Balance Wheel Friction Ring Stop Pin for 16592.....
8238	7429	Tension (upper) Spring for 19153, obsolete
8505	7428	Face Plate Thread Guard (upper) Rivet for 2827.....
8511	7436	Thread Take-up Spring for 57-14 Machine
8582	1150	Arm Dowel Pin.....
8908	1161	Wrench for 1520 (Attachments and Accessories).....
9079	1164	Driving Attachment Treadle Pitman Rod Clamp with 354c, for 27640.....
10141	1150	Bobbin Winder Tension Spring for 27308..
10165	1150	Lap Seam Feller Folder Slide Stop Pin for 20636.....
10236	7429	Driving Attachment Driving Friction Pulley Center Bearing for 16594.....
*11104	—	Arm Shaft Bushing (front) for 12355, 21001 and 21022.....
11119	1150	Arm Oil Tube with 52045, for oiling 12408 and 19156.....

NO.	PLATE	NAME
11167	1142	Presser Bar Spring (light) .051 wire.....
11170	1150	“ “ “ Washer.....
11204	1144	Thread Take-up Lever Link Hinge Pin...
11241	1142	Arm Spool Bracket Spool Pin Washer (cloth) for 57-2 Machine.....
11241	1142	Arm Spool Pin Washer (cloth) for 57-3, 57-4 and 57-14 Machines.....
11241	1142	Bobbin Winder Spool Pin Washer (cloth) for 27308.....
12139	1142	Presser Bar Spring (medium) .055 wire...
12149	1150	Tension Thread Guard.....
12150	7428	Face Plate Thread Guard (lower) with 12152, for 12367.....
12152	1150	Face Plate Thread Guard (lower) Rivet for 12150 and 19327.....
12152	1150	Face Plate Thread Guard (upper) Rivet for 19155.....
12166	1144	Thread Take-up Lever Hinge Pin for 12410 and 19157.....
12178	7429	Driving Attachment Driving Arm Friction Plug (wood) for 20670.....
12193	1143	Arm Side Cover.....
12237	4321	Lifting Lever with 448c, for 21028 and 21032.....
12240	1145	Lifting Lever Pin for 21028 and 21032...
12241	1145	“ “ Link for 21028 and 21032...
12326	1145	Presser Bar Guide Bracket with 453c....
12327	1145	“ “ Lifting and Releasing Lever Bracket.....
12329	1145	Tension Releasing Lever Spring.....
*12355	----	Arm with 11104, for 57-14 Machine.....
12357	1142	“ Shaft Flanged Bushing (back).....
12358	1140	Balance Wheel (power) light rim, 2 1/8 in. pulley, with two 448c.....
12366	----	Face Plate for 12367.....
12367	1170	Face Plate complete for 57-3, 57-4 and 57-14 Machines, Nos. 2827, 12150 and 12366.....
12381	1170	Needle Bar (hollow) for 57-3 and 57-14 Machines.....
12382	1144	Needle Bar Connecting Link with 794E...
*12383	----	“ “ “ Stud for 12384...
12384	1144	Needle Bar Connecting Stud complete, Nos. 453c, 1904 and 12383.....
12388	1142	Oscillating Rock Shaft Hinge Pin for 19167 and 19387.....
12390	1160	Oscillating Shaft Crank complete, Nos. 457c, 1518E, 1902 and 19496, obsolete..

NO.	PLATE	NAME
12391	1170	Presser Bar (hollow) for 57-3 and 57-14 Machines.....
12397	1145	Tension Releasing Lever for 57-2 Machine
12398	1145	“ “ “ Hinge Pin.....
12403	1150	Arm Spool Bracket Spool Pin and Thread Eyelet for 15063.....
12403	1150	Arm Spool Pin and Thread Eyelet for 57-3, 57-4 and 57-14 Machines.....
12404	7428	Thread Take-up Crank for 57-3, 57-4 and 57-14 Machines and obsolete for 57-2 Machine.....
12408	7428	Thread Take-up Lever for 12410.....
12409	1144	Thread Take-up Lever Link for 12410 and 19157.....
12410	----	Thread Take-up Lever complete for 57-3, 57-4 and 57-14 Machines, Nos. 12166, 12408 and 12409.....
12416	1145	Pitman Joint for 21028 and 21032.....
12424	1149	Oscillating Shaft Crank Slide Block Cap Screw Washer for 19390.....
12427	7434	Arm Shaft for 57-14 Machine.....
12443	1160	Oscillating Rock Shaft Oil Pad for 16508, obsolete.....
12453	1150	Arm Oil Tube, for intermediate bearing..
12454	1150	“ “ “ with 52045, for oiling 12409
12480	1143	“ Side Cap.....
13351	----	Chain, 46 in. to 55 in. long, with 56864 and 56865, for 21028.....
14209	3477	Treadle for 14358.....
Nos. 14229 to 14231 for 14232		
14229	4321	Driving Attachment Table Belt Guide Bracket with 448c.....
14230	4321	Driving Attachment Table Belt Guide Pulley.....
14231	1170	Driving Attachment Table Belt Guide Pulley Shaft 126928 with 858c.....
14232	4321	Driving Attachment Table Belt Guide complete for 20676, Nos. 14229 to 14231 and four R. H. M. F. O. and A. wood screws 1 1/4 in. No. 10.....
14357	3477	Treadle Stand for 14358.....
14358	3477	Treadle complete for 21028, Nos. 7585, 14209, 14357 and two wood screws 1 1/4 in. No. 12.....
15063	1140	Arm Spool Bracket 2415 with two 12403, for 57-2 Machine.....

NO.	PLATE	NAME
15072	1150	Bobbin Winder Bobbin Position Pin for 27538.....
15132	7429	Driving Attachment Driving Arm Brake Rivet for 20667.....
16045	1150	Oscillating Shaft (back bearing) Oil Tube
16128	1167	Rock Shaft Hanger (front) with two wood screws 1 in. No. 10, for 16129.....
16129	1167	Rock Shaft complete for 21032, Nos. 2764, 6337, 6338, 7124, 16128, 16647 and two 2770.....
16508	1160	Oscillating Rock Shaft Oil Pad Holder with 12443, obsolete.....
16524	—	Driving Attachment Balance Wheel Friction Ring (leather) for 16592.....
16592	1167	Driving Attachment Balance Wheel (friction) with 7958, 16524 and two 435c, for 20676.....
16594	1167	Driving Attachment Driving Friction Pulley, 2 $\frac{5}{8}$ in. diam., with 861b and 10236, for 20676.....
16646	1167	Rock Shaft Knee Arm for 16647.....
16647	—	Rock Shaft Knee Arm complete for 16129, Nos. 2766, 2767 and 16646.....
18014	1142	Needle Bar (hollow) for 57-2 Machine....
18055	7429	Presser Foot Hinge Pin for 20761.....
19131	5737	Shuttle Bobbin for 20758.....
19131	1148	" (inside) Bobbin for 20531.....
19137	1148	" (outside) Body for 20532.....
19149	1148	" (inside) Tension Spring for 20533
19150	1148	" (outside) Tension Spring for 20534
19151	1160	Tension Plate, for upper tension, with 19152, for 19153, obsolete.....
19152	1160	Tension Plate Stud for 19151, obsolete...
19153	1160	Tension (upper) complete, Nos. 19151, two each 637c, 1547b, 1560c, 8238 and four 2102, obsolete.....
19155	1150	Face Plate Thread Guard (upper) with 12152, for 19305.....
19156	1144	Thread Take-up Lever for 19157.....
19157	1144	Thread Take-up Lever complete for 57-2 Machine, Nos. 12166, 12409 and 19156
19158	1150	Thread Take-up Spring for 57-2 to 57-4 Machines.....
Nos. 19159 to 19161 for 19162		
19159	1149	Thread Guide Body.....
19160	1149	" " Roller.....
19161	1149	" " Cap.....

NO.	PLATE	NAME
19162	—	Thread Guide complete (roller) for 57-2 Machine, Nos. 905b and 19159 to 19161
19166	1142	Oscillating Rock Shaft for 19167, obsolete
19167	—	" " " 19166 with 12388, obsolete.....
Nos. 19191 to 19194 for 19195		
19191	1146	Tension Plate, for upper tension, with 19231.....
19192	1146	Tension Releaser.....
19193	1146	" Releasing Lever (intermediate)
19194	1146	" " " " " " " "
Spring.....		
19195	1146	Tension complete (upper) with Tension Release, for 57-2 Machine, Nos. 2269, 19191, 19193, 19194, two each 1547b, 2923, 19192, 44209 and four 2921.....
19221	1161	Wrench for 936 and 1619 (Attachments and Accessories).....
19231	1146	Tension Releasing Lever (intermediate) Hinge Block for 19191.....
19294	1153	Lap Seam Feller Folder Slide Spring for 57-2 Machine.....
19304	—	Face Plate for 19305.....
19305	1143	Face Plate complete for 57-2 Machine, Nos. 19155, 19304 and 19327.....
19327	7428	Face Plate Thread Guard (lower) with 12152, for 19305.....
19334	—	Presser Foot Plate for 19336.....
19335	—	" " Shank for 19336.....
19336	7426	Presser Foot (hinged) complete for 57-4 Machine, Nos. 7298, 19334 and 19335..
19386	1142	Oscillating Rock Shaft for 19387.....
19387	—	Oscillating Rock Shaft complete, Nos. 4784, 12388 and 19386.....
19388	1149	Oscillating Shaft Crank complete for 57-2, and 57-4 Machines, Nos. 457c, 1518e, 19390 and 19496.....
19389	1149	Oscillating Shaft Crank Slide Block for 19390.....
19390	1149	Oscillating Shaft Crank Slide Block complete for 19388 and 20750, Nos. 226e, 969c, 12424 and 19389.....
19496	—	Oscillating Shaft Crank for 12390 and 19388.....
20023	1142	Presser Bar Spring (heavy) .063 wire....
20188	1142	Needle Bar Crank with 858c and 1065c...

NUMERICAL LIST OF PARTS

NO.	PLATE	NAME
20197	1141	Crank Connecting Rod with 20198 and two 896E.....
*20198	---	Crank Connecting Rod Cap for 20197...
20502	1150	Arm Oil Tube with 29599, for oiling 12496 and 20197.....
20505	1142	Cylinder Feed Cover for 57-2 to 57-4 Machines.....
Nos. 20507 to 20512 FOR 26353, 26390, 26392 AND 57-2 MACHINE		
20507	1151	Feed Dog, 16 teeth (12 teeth to the inch) for $\frac{1}{4}$ in. to $\frac{5}{16}$ in. gauges.....
20508	1152	Feed Dog, 13 teeth (12 teeth to the inch) for $\frac{3}{8}$ in. to $\frac{5}{8}$ in. gauges.....
20509	1153	Feed Dog, 13 teeth (12 teeth to the inch) for $\frac{1}{4}$ in. to $\frac{3}{8}$ in. gauges.....
20510	1152	Feed Dog, 13 teeth (12 teeth to the inch) for $\frac{3}{8}$ in. to $\frac{5}{8}$ in. gauges (spiked teeth) for heavy work on duck, overalls, etc....
20511	1153	Feed Dog, 13 teeth (12 teeth to the inch) for $\frac{1}{4}$ in. to $\frac{3}{8}$ in. gauges (spiked teeth) for heavy work on duck, overalls, etc....
20512	1151	Feed Dog, 16 teeth (12 teeth to the inch) for $\frac{1}{4}$ in. to $\frac{5}{16}$ in. gauges (spiked teeth) for heavy work on duck, overalls, etc....
20513	1154	Feed Dog, 21 teeth (16 teeth to the inch) for $\frac{3}{8}$ in. to $\frac{5}{16}$ in. gauges, for staying, for 57-2 Machine.....
20514	1175	Feed Dog, 21 teeth (16 teeth to the inch) for $\frac{1}{4}$ in. to $\frac{5}{16}$ in. gauges, for 26353, 26390, 26392 and 57-2 Machine.....
20515	1152	Feed Dog, 23 teeth (22 teeth to the inch) for $\frac{3}{8}$ in. to $\frac{5}{8}$ in. gauges, for 26353, 26390, 26392 and 57-2 Machine.....
20518	1141	Feed Forked Connection with 20519 and two 175E, for 57-2 to 57-4 Machines...
*20519	---	Feed Forked Connection Cap for 20518...
20520	1145	" Raising Fork for 57-2 to 57-4 Machines.....
20521	1142	Feed Regulator.....
20522	1141	" Rock Shaft for 57-2 to 57-4 Machines
20523	1141	" " " Arm with 460c, for 57-2 to 57-4 Machines.....
20524	1150	Needle Clamp with two 209E, for 57-2 Machine.....
20526	1142	Presser Bar for 20527, obsolete.....
20527	1156	" Foot (hinged) Nos. 20528 to 20530, obsolete.....

NUMERICAL LIST OF PARTS

NO.	PLATE	NAME
20528	---	Presser Foot Shank for 20527, obsolete...
20529	---	" " Plate for 20527, obsolete....
20530	1150	" " Hinge Pin for 20527, 20638, 20643, 20646, 20648, 20682, 20754, 20777 and 21014.....
20531	1148	Shuttle (inside) $1\frac{1}{8}$ in. diam., for 57-2 Machine, Nos. 19131, 20533 and 20540
20532	1148	Shuttle (outside) $1\frac{1}{8}$ in. diam., for 57-2 Machine, Nos. 19131, 19137 and 20534
20533	1148	Shuttle (inside) Bobbin Case complete for 20531, Nos. 591E, 592E, 2521, 19149, 20536 and 20774.....
20534	1148	Shuttle (outside) Bobbin Case complete for 20532, Nos. 591E, 592E, 2521, 19150, 20537 and 20775.....
20535	1149	Shuttle Bobbin Case Extractor (Attachments and Accessories).....
20536	1148	Shuttle (inside) Bobbin Case Latch and Position Finger for 20533.....
20537	1148	Shuttle (outside) Bobbin Case Latch and Position Finger for 20534.....
20538	1147	Shuttle (inside) Bobbin Case Position Plate for 20543.....
20539	1147	Shuttle (outside) Bobbin Case Position Plate for 20543.....
20540	1148	Shuttle (inside) Body for 20531.....
20543	1147	Shuttle Race complete for 57-2 Machine, Nos. 935E, 20538, 20539, 20544, 20545 and two each 190b and 662b.....
20544	---	Shuttle Race Body for 20543.....
20545	1147	" " Loop Separator for 20543...
20548	1151	Throat Plate, small needle hole, for lap seam feller, for 20507, 20512 and 20514
20549	1152	Throat Plate, for lap seam feller, for 20508, 20510 and 20515.....
20550	1153	Throat Plate, for lap seam feller, for 20509 and 20511.....
20551	1154	Throat Plate for 20513.....
20552	1175	" " " 20507, 20512 and 20514
20553	1176	" " " 20508, 20510 and 20515
20554	1176	" " " 20509 and 20511.....
20555	---	" " large needle hole, for lap seam feller, for 20507, 20512 and 20514.....
20556	1177	Throat Plate complete for 20509 and 20511, for lap seam feller, for 57-2 Machine, Nos. 20687, 20688 and two 1053b.....
20557	1178	Throat Plate with 4515, for 20513.....

NUMERICAL LIST OF PARTS

NO.	PLATE	NAME
20558	1140	Pitman, 13 in. long, for 21028 and 21032..
20559	1140	Lifting Lever Spring for 21028 and 21032
20561	1164	Drip Pan
20562	1143	Cylinder Cover for 26277.....
20563	1142	Presser Bar (hollow) for 57-2 and 57-4 Machines.....
20564	7434	Cloth Plate for 20565.....
20565	—	Cloth Plate complete for 20566, Nos. 3286, 20564, 20568 and two 240.....
20566	—	Cloth Plate with Bracket complete for 57-14 Machine, Nos. 20565, 20567 and two 389.....
20567	7435	Cloth Plate Bracket with 345c, for 20566
20568	7435	“ “ Slide for 20565.....
20573	7432	Feed Dog, 13 teeth (18 teeth to the inch) for shirt work, for 57-14 Machine.....
20577	7433	Feed Dog, 12 teeth (18 teeth to the inch) for 57-14 Machine.....
20579	7432	Feed Dog, 13 teeth (18 teeth to the inch) for shirt work, for 57-14 Machine.....
20581	7435	Feed Forked Connection for 57-14 Ma- chine.....
20583	7436	Feed Rock Shaft Crank with 190b, for 57-14 Machine.....
20587	7432	Presser Foot (concave feed dog bearing) for 20577, for 57-14 Machine.....
20588	7432	Presser Foot (concave feed dog bearing) for 20573, for 57-14 Machine.....
20589	1193	Presser Foot for 20662 and 20685, for 57-3 Machine.....
20621	7427	Shuttle Driver and Feed Lifting Eccentric for 57-3 and 57-4 Machines.....
20625	7426	Presser Foot for 20656 and 20664, for 57-3 Machine.....
20630	1179	Feed Dog, 22 teeth (16 teeth to the inch) for $\frac{1}{8}$ in. to $\frac{3}{8}$ in. gauges, for shirt closing, for 57-2 Machine.....
20631	987	Feed Dog, 22 teeth (16 teeth to the inch) for $\frac{1}{8}$ in. to $\frac{3}{8}$ in. gauges, for shirt closing, for 57-2 Machine.....
20632	1179	Throat Plate with 2653, for 20630 and 26339.....
20633	987	Throat Plate with 2653, for 20631 and 26339.....
20636	—	Lap Seam Feller Folder Slide with 10165, for 26353, 26390, 26392 and 26394.....
20637	—	Presser Foot Plate for 20638.....

NUMERICAL LIST OF PARTS

NO.	PLATE	NAME
20638	1152	Presser Foot (hinged) complete, for lap seam feller, for 57-2 Machine, Nos. 330j, 20530, 20637 and 21016.....
20640	7437	Feed Rock Shaft Oil Tube, for back bear- ing, for 57-14 Machine.....
20641	1143	Cylinder Cover for 57-2 and 57-3 Machines
20642	—	Presser Foot Plate for 20643.....
20643	1154	Presser Foot (hinged) complete, for inside stays, for 20551, Nos. 330j, 20530, 20642 and 21016.....
20645	—	Presser Foot Plate for 20646.....
20646	1156	Presser Foot (hinged) complete, for staying seams, for 57-2 Machine, Nos. 330j, 20530, 20645 and 21016.....
20647	—	Presser Foot Plate for 20648.....
20648	1156	Presser Foot (hinged) complete, for strip folding, with guide for opening seams, for 57-2 Machine, Nos. 330j, 20530, 20647 and 21016.....
20649	5737	Shuttle Bobbin Case Latch for 20650.....
20650	—	Shuttle Bobbin Case Hinge for 20756, Nos. 2973, 2974 and 20649.....
20654	5737	Shuttle Tension Spring for 20756.....
20656	1189	Feed Dog, 18 teeth (16 teeth to the inch) for shirt work, for 57-3 Machine.....
20657	1189	Throat Plate for 20656.....
20659	7435	Shuttle Race with 20700 and two 1053b, for 57-14 Machine.....
20662	1190	Feed Dog, 15 teeth (16 teeth to the inch) for tailor work, for 57-3 Machine.....
20663	1190	Throat Plate for 20662.....
20664	1191	Feed Dog, 13 teeth (14 teeth to the inch) for shirt work, for 57-3 Machine.....
20665	1191	Throat Plate, large needle hole, for 20664
20666	—	“ “ small needle hole, for 20664
Nos. 20667 to 20669 for 20670		
20667	4314	Driving Attachment Driving Arm with 2928 and two 15132.....
20668	4314	Driving Attachment Driving Arm Bracket
20669	4314	“ “ “ “ Shaft..
20670	—	Driving Attachment Driving Arm com- plete for 20676, Nos. 341b, 427e, 1508c, 1594c, 12178, 20667 to 20669, 20671, 20672, 20675, 20678 and two 20677....
20671	4314	Driving Attachment Starting Crank for 20670.....

NUMERICAL LIST OF PARTS

NO.	PLATE	NAME
20672	4314	Driving Attachment Starting Crank Spring for 20670.....
20673	4321	Driving Attachment Rock Shaft complete for 20676, Nos. 2763 and two each 2764 and 27683.....
20674	4314	Driving Attachment Starting Crank Connecting Rod for 20676.....
20675	7429	Driving Attachment Starting Crank Connecting Rod Joint for 20670.....
20676	—	Driving Attachment with Rock Shaft and Treadle complete. Nos. 210b, 692b, 1620E, 16592, 16594, 20670, 20673, 20674, 24355, 27072, 126210 and two 14232.....
20677	7429	Driving Attachment Driving Arm Pin for 20670.....
20677	7429	Driving Attachment Starting Crank Pin for 20670.....
20678	7429	Driving Attachment Starting Crank Connecting Rod Joint Hinge Stud for 20670.....
20680	—	Presser Foot Plate for 20682.....
20681	—	" " Shank for 20682.....
20682	1156	Presser Foot (hinged) complete, hollowed across bottom between needle holes and heel, for riding seams, for lap seam feller, for 57-2 Machine, Nos. 330J, 20530, 20680 and 20681.....
20685	1193	Feed Dog, 20 teeth (16 teeth to the inch) for overall work, for 57-3 and 57-4 Machines.....
20686	1193	Throat Plate for 20685.....
20687	—	" " Body, for 20556.....
20688	1177	" " Needle Hole Strip for 20556.....
20697	7436	Shuttle Driver and Feed Lifting Cam for 57-14 Machine.....
20698	—	Throat Plate, large needle hole, for 20573.....
20699	7432	" " small needle hole, for 20573.....
20700	7436	Shuttle Race Cap for 20659.....
20701	7437	Feed Dog Carrier for 57-14 Machine.....
20708	—	Throat Plate, large needle hole, for 20577.....
20709	7433	" " small needle hole, for 20577.....
20711	1171	Presser Foot (strip folding) with 330J, for 57-2 Machine.....
20712	1171	Presser Foot (tube) with 330J, for 57-2 Machine.....
20713	4320	Shuttle Bobbin Case Guide Plate for 20717 and 20718.....

NUMERICAL LIST OF PARTS

NO.	PLATE	NAME
20714	4320	Shuttle Race Cap for 20717 and 20718.....
20715	—	" " Body for 20717.....
20716	—	" " " " 20718.....
20717	4320	Shuttle Race complete (steel) for 57-4 Machine, Nos. 20713 to 20715 and two each 399J and 934b.....
20718	7427	Shuttle Race complete (steel) for 57-3 Machine, Nos. 20713, 20714, 20716 and two each 399J and 934b.....
20719	7437	Shuttle Race Cover for 57-14 Machine.....
20747	4521	Machine Base with four each 121E and wood screws 1 1/4 in. No. 12.....
20748	7432	Throat Plate for 20679.....
20749	—	Oscillating Shaft Crank for 20750.....
20750	7427	Oscillating Shaft Crank complete for 57-3 and 57-14 Machines, Nos. 219c, 1518E, 19890 and 20749.....
20751	1175	Throat Plate for 20630.....
20753	—	Presser Foot Plate for 20754.....
20754	1171	Presser Foot (hinged) complete with guide on bottom of plate to the right of needle hole, for 57-2 Machine, Nos. 330J, 20530, 20753 and 21016.....
20755	5737	Shuttle Bobbin Case Position Finger for 20756.....
20756	5737	Shuttle Bobbin Case complete for 20758, Nos. 591E, 592E, 2523, 2975, 20650, 20654 and 20755.....
20757	5737	Shuttle Body for 20758.....
20758	5737	Shuttle, 1 1/8 in. diam., for 57-3, 57-4 and 57-14 Machines, Nos. 19131, 20756 and 20757.....
20759	—	Presser Foot Plate for 20761.....
20760	—	" " Shank for 20761.....
20761	1171	Presser Foot (spring hinged) complete, for lap seam feller, for 57-2 Machine, Nos. 330J, 18055, 20759, 20760 and 35250.....
20774	—	Shuttle (inside) Bobbin Case for 20533.....
20775	—	" (outside) Bobbin Case for 20534.....
20776	—	Presser Foot Plate for 20777.....
20777	7436	Presser Foot (hinged) complete, with tube for tape and guide for opening seams, for 57-2 Machine, Nos. 330J, 20530, 20776 and 21016.....
20783	7436	Shuttle Driver and Feed Lifting Eccentric for 57-2 Machine.....
*21001	—	Arm with 11104 for 57-2 Machine.....

NO.	PLATE	NAME
Nos. 21002 to 21007 for 57-2 to 57-4 MACHINES		
21002	1167	Arm Shaft.....
21003	1166	" " Gear with 453c and 454c, obsolete.....
21004	1140	Arm Side Wheel with two 450c.....
21005	1166	" " " Shaft.....
21006	1166	" " " " Collar with 449c..
21007	1166	" " " " Gear with 453c and 454c, obsolete.....
21008	1166	Arm Side Wheel Shaft Gear Cover for 21009.....
21009	—	Arm Side Wheel Shaft Gear Cover 21008 with 460c and 21019, for 21010.....
21010	1166	Arm Side Wheel Shaft Gear Cover complete for 57-2 Machine, Nos. 21009 and 21038.....
*21011	—	Cylinder, 2 $\frac{1}{8}$ in. diam., for 57-2 Machine
21012	1141	Feed Rod for 57-2 to 57-4 Machines.....
21013	1141	Oscillating Shaft for 57-2 to 57-4 Machines
21014	1151	Presser Foot (hinged) complete, for general work, for 57-2 Machine, Nos. 330j, 20530, 21015 and 21016.....
21015	—	Presser Foot Plate for 21014.....
21016	—	" " Shank for 20638, 20643, 20646, 20648, 20754, 20777 and 21014..
21017	1156	Presser Foot (solid) with 330j, for 57-2 Machine.....
21019	1166	Thread Retainer Body for 21009.....
21020	1166	" " Thread Separator for 21038.....
*21022	—	Arm with 11104, for 57-3 and 57-4 Machines.....
21023	1170	Arm Side Wheel Shaft Gear Cover for 57-3 and 57-4 Machines.....
*21024	—	Cylinder, 2 $\frac{1}{8}$ in. diam., for 57-3 and 57-4 Machines.....
21026	1166	Arm Shaft Gear with 453c and 454c, for 57-2 to 57-4 Machines.....
21027	1166	Arm Side Wheel Shaft Gear with 453c and 454c, for 57-2 to 57-4 Machines.....
21028	—	Foot Lifter complete, Nos. 76D, 766D, 802D, 1521E, 12237, 12240, 12241, 12416, 13351, 14358, 20558 and 20559.....
*21029	—	Cylinder, 2 $\frac{1}{8}$ in. diam., for 57-14 Machine

NO.	PLATE	NAME
21030	7434	Feed Rock Shaft for 57-14 Machine.....
21031	7435	Oscillating Shaft for 57-14 Machine.....
21032	—	Knee Lifter complete, Nos. 76D, 766D, 802D, 1521E, 12237, 12240, 12241, 12416, 16129, 20558 and 20559.....
21037	7428	Thread Retaining Stud for 21038.....
21038	—	Thread Retainer complete for 21010, Nos. 21020, 21037, 210958, 210992 and 210993.....
21040	7425	Cylinder Cover for 57-4 Machine.....
21041	1170	Needle Bar (hollow) with 857H, for 57-4 Machine.....
21042	7428	Presser Bar Extension with two 202E, for 57-4 Machine.....
21043	7428	Presser Bar Extension Foot Bar for 57-4 Machine.....
21044	7425	Throat Plate for 20685.....
23258	7438	Driving Attachment Treadle Bracket (left) Hook Friction Washer for 126206.....
23724	7429	Arm Shaft Gear Pin for 57-2 to 57-4 Machines.....
23724	7429	Arm Side Wheel Pin for 57-2 to 57-4 Machines.....
23724	7429	Arm Side Wheel Shaft Collar Pin for 57-2 to 57-4 Machines.....
23724	7429	Arm Side Wheel Shaft Gear Pin for 57-2 to 57-4 Machines.....
24129	1144	Thread Take-up Crank for 57-2 Machine
24355	1170	Driving Attachment Balance Wheel Oil Cover for 20676.....
25888	987	Hemmer Tongue, for shirt closing, for 57-2 Machine.....
26026	1161	Screw Driver, machine (Attachments and Accessories).....
26054	987	Throat Plate Cloth Guide for 20632 and 20633.....
26277	1153	Lap Seam Feller Holder (adjustable) for 57-2 Machine.....
26337	987	Hemmer (foot) for felling, for shirt closing, for 57-2 Machine.....
26338	987	Hemmer Bracket with two 211E, for shirt closing, for 26337.....
26339	987	Throat Plate Spring Guide for 20632 and 20633.....
*26352	—	Lap Seam Feller Folder for 26353.....

NO.	PLATE	NAME
26353	1155	Lap Seam Feller (right hand) complete for 57-2 Machine, for gauges $\frac{3}{8}$ in. to $\frac{1}{8}$ in., for light, medium, heavy, X-heavy, XX-heavy and XXX-heavy material, Nos. 20636 and 26352
26384	1155	Stay Guide (lower) for 26386.....
26385	1155	" " (upper) for 26386.....
26386	—	Stay Guide complete for 57-2 Machine, Nos. 26384 and 26385.....
*26389	—	Lap Seam Feller Folder for 26390.....
26390	1155	Lap Seam Feller (left hand) complete for 57-2 Machine, for gauges $\frac{3}{8}$ in. to $\frac{1}{8}$ in., for light, medium, heavy, X-heavy, XX-heavy and XXX-heavy material, Nos. 20636 and 26389
*26391	—	Lap Seam Feller Folder for 26392.....
26392	1155	Lap Seam Feller (right hand) complete for 57-2 Machine, to fold top only, Nos. 20636 and 26391.....
*26393	—	Lap Seam Guide for 26394.....
26394	1156	Lap Seam Guide complete for 57-2 Machine, Nos. 20636 and 26393.....
26485	1161	Screw Driver, shuttle tension (Attachments and Accessories).....
27072	7431	Driving Attachment Shaft Driving Pulley (sectional, grooved) 12 in. diam., $1\frac{1}{8}$ in. bore, with two 597c, for 20676.....
27302	1162	Bobbin Winder Frame for 27651.....
27303	1150	" " " Spring for 27651..
27306	1162	" " Spool Pin for 27308.....
27307	1162	" " " Stand for 27308....
27308	1162	Bobbin Winder Spool Stand complete for 27588, Nos. 418E, 1562r, 2106, 10141, 11241, 27306, 27307 and two each 2455 and wood screws 1 in. No. 10.....
27538	1162	Bobbin Winder Spindle 27849 with 15072, 27850 and 41828, for 27651.....
27552	1162	Bobbin Winder Base for 27651.....
27553	1162	" " Pulley for 27651.....
27587	1162	" " Stop Latch for 27651.....
27588	—	Bobbin Winder (swinging automatic, right hand) complete, Nos. 27308 and 27651
Nos. 27637 to 27639 for 27640		
27637	1164	Driving Attachment Treadle Pitman Rod (lower).....

NO.	PLATE	NAME
27638	1164	Driving Attachment Treadle Pitman Rod (lower) Spring.....
27639	1164	Driving Attachment Treadle Pitman Rod (upper).....
27640	1164	Driving Attachment Treadle Pitman complete for 126210, Nos. 2762, 6055, 27637 to 27639 and two 9079.....
27651	1162	Bobbin Winder for 27588, Nos. 35D, 1620r, 27302, 27303, 27538, 27552, 27553, 27587, 50356D and two wood screws 1 in. No. 7.....
27683	4321	Driving Attachment Rock Shaft Arm with two 356c, for 20673.....
27739	7234	Thread Unwinder Thread Cone (wood) for large cones, for 225394 and 225396.....
27849	—	Bobbin Winder Spindle for 27538.....
27850	—	" " " Collar for 27538..
29599	7429	Arm Oil Tube Packing (felt) for 20502...
32572	7428	Tension Releasing Disc for 57-3, 57-4 and 57-14 Machines.....
32574	7428	Tension Releasing Pin for 57-3, 57-4 and 57-14 Machines.....
35250	7429	Presser Foot Spring for 20761.....
41828	—	Bobbin Winder Spindle Collar Pin for 27538.....
43944	7428	Tension Releasing Lever for 57-3, 57-4 and 57-14 Machines.....
43945	7428	Tension Spring for 57-3, 57-4 and 57-14 Machines.....
44141	—	Tension Screw Stud 50327c with 1560c, for 57-3, 57-4 and 57-14 Machines.....
44209	—	Tension Screw Stud 916c with 1560c, for 19195.....
46681	7435	Driving Attachment Treadle Bracket (right) for 60502.....
50327c	7428	Tension Screw Stud for 44141.....
50356D	7430	Bobbin Winder Frame Hinge Screw for 27651.....
50429c	7438	Thread Retainer Set Screw for 57-14 Machine.....
51077E	7438	Bolt with 51581E, to secure machine to table (Attachments and Accessories)...
51581E	7438	Bolt Nut for 51077.....
52045	7438	Arm Oil Tube Packing (braided cotton) for 11119 and 12454.....
52378	7428	Thread Retaining Stud for 52379.....

NO.	PLATE	NAME
52379	—	Thread Retainer complete for 57-3 and 57-4 Machines, Nos. 52378, 52398, 210958 and 210993.....
52398	7428	Thread Retaining Spring for 52379.....
52454	7436	" Retainer for 57-14 Machine.....
56864	7438	Chain Hook (large) for 13351.....
56865	7438	" " (small) for 13351.....
60502	—	Driving Attachment Treadle Bracket (right) 46681 with two wood screws 1 in. No. 14, for 126209.....
120341	1161	Tweezers, curved (Attachments and Accessories).....
120346	1161	Oiler (copper plated) with 120347 (Attachments and Accessories).....
120347	1161	Oiler Spout, 9 inches long, for 120346....
126036	3477	Driving Attachment Treadle for 126209..
126205	7435	" " " Bracket (left) for 126206.....
126206	—	Driving Attachment Treadle Bracket (left) complete for 126209, Nos. 23258, 126205, 126207, 126208 and two wood screws 1 in. No. 14.....
126207	7438	Driving Attachment Treadle Bracket (left) Hook for 126206.....
126208	7438	Driving Attachment Treadle Bracket (left) Hook Rivet for 126206.....
126209	—	Driving Attachment Treadle complete for 126210, Nos. 60502, 126036 and 126206.....
126210	—	Driving Attachment Treadle and Pitman complete for 20676, Nos. 27640 and 126209.....
126928	—	Driving Attachment Table Belt Guide Pulley Shaft for 14231.....
200383c	7438	Thread Unwinder Spool Rest Rod Set Screw for 202490.....
201018c	7438	Thread Unwinder Spool Rest Set Screw for 225389 and 225395.....
201696j	7438	Thread Unwinder Thread Guide Lock Nut for 225394 and 225396.....
202490	7233	Thread Unwinder Spool Stand with 200383c, for 225394 and 225396.....
210958	7428	Thread Retaining Collar for 21038 and 52379.....
210992	7428	Thread Retaining Spring for 21038.....
210993	7428	" " Sleeve for 21038 and 52379.....

NO.	PLATE	NAME
225388	7233	Thread Unwinder Spool Rest Rod for 225394 and 225396.....
225389	8523	Thread Unwinder Spool Rest with 201018c, for 225394.....
Nos. 225390 TO 225392 FOR 225394 AND 225396		
225390	7234	Thread Unwinder Thread Cone Holder for inverted cones.....
225391	7233	Thread Unwinder Thread Guide.....
225392	7233	" " " " Rod with 208E and 225393.....
225393	7438	Thread Unwinder Thread Guide Rod Washer for 225392.....
225394	8523	Thread Unwinder complete, for one spool, Nos. 201696j, 202490, 225388, 225389, 225391, 225392 and three wood screws $\frac{7}{8}$ in. No. 12.....
225395	7233	Thread Unwinder Spool Rest with 201018c, for 225396.....
225396	7233	Thread Unwinder complete, for two spools, Nos. 201696j, 202490, 225388, 225392, 225395, two 225391 and three wood screws $\frac{7}{8}$ in. No. 12.....

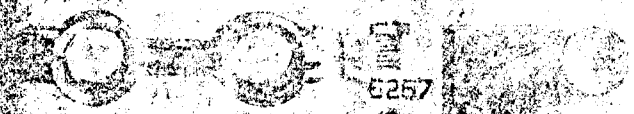
Genuine Singer Needles and their Containers are marked with the Company's Trade Mark "SIMANCO." 1

Needles in Containers marked "For Singer Machines" are not Singer made needles. 2

20032

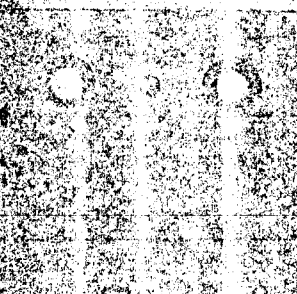
211

26307



2257

20033



5808

2103

ILLUSTRATIONS OF PARTS

FOR

MACHINES

Nos. 57-2 to 57-4 and 57-14

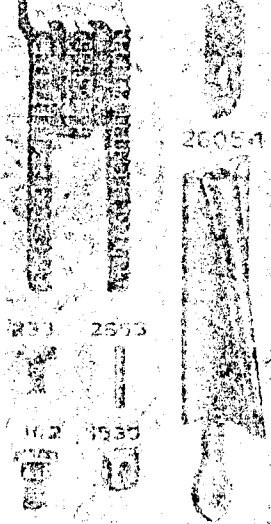
20054

231

2693

172

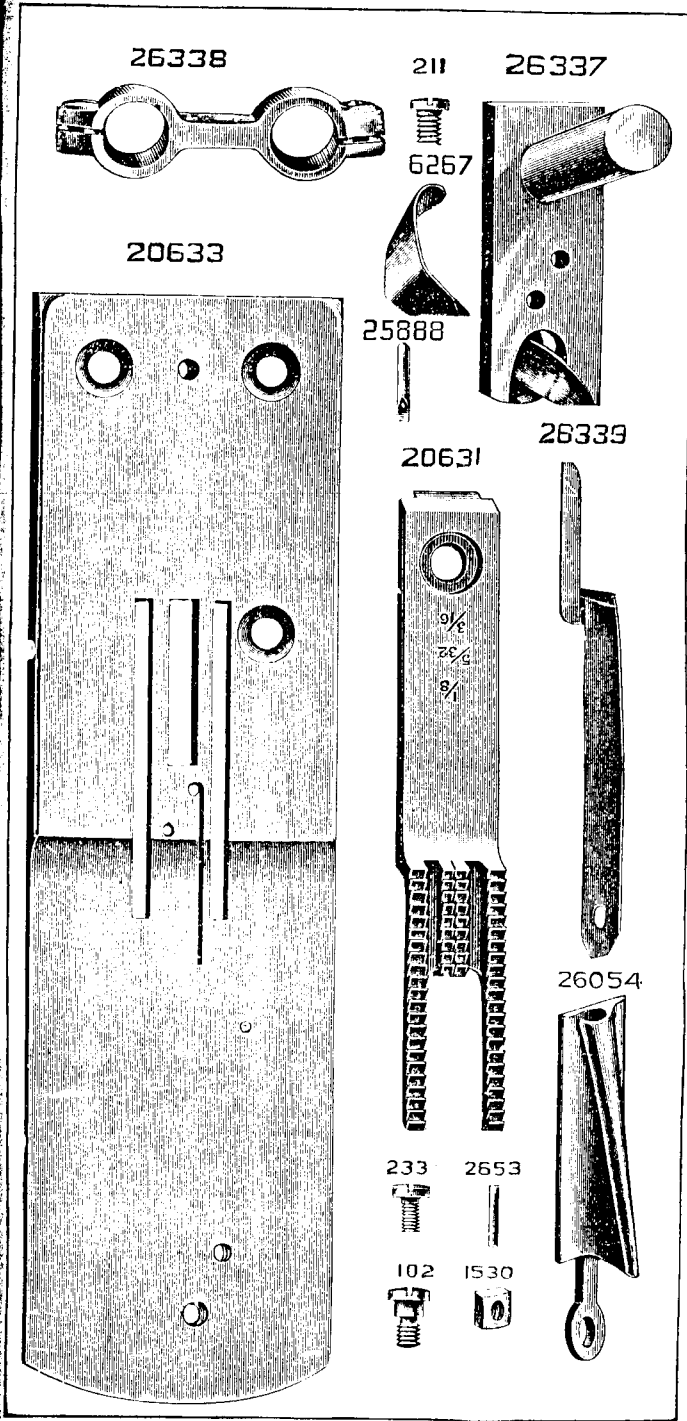
1930



From the library of: Diamond Needle Corp

PLATE 987—FULL SIZE

ILLUSTRATIONS OF PARTS
FOR
MACHINES
Nos. 27-2 to 27-4 and 27-14



From the library of: Diamond Needle Corp

PLATE 1140—ONE-HALF SIZE

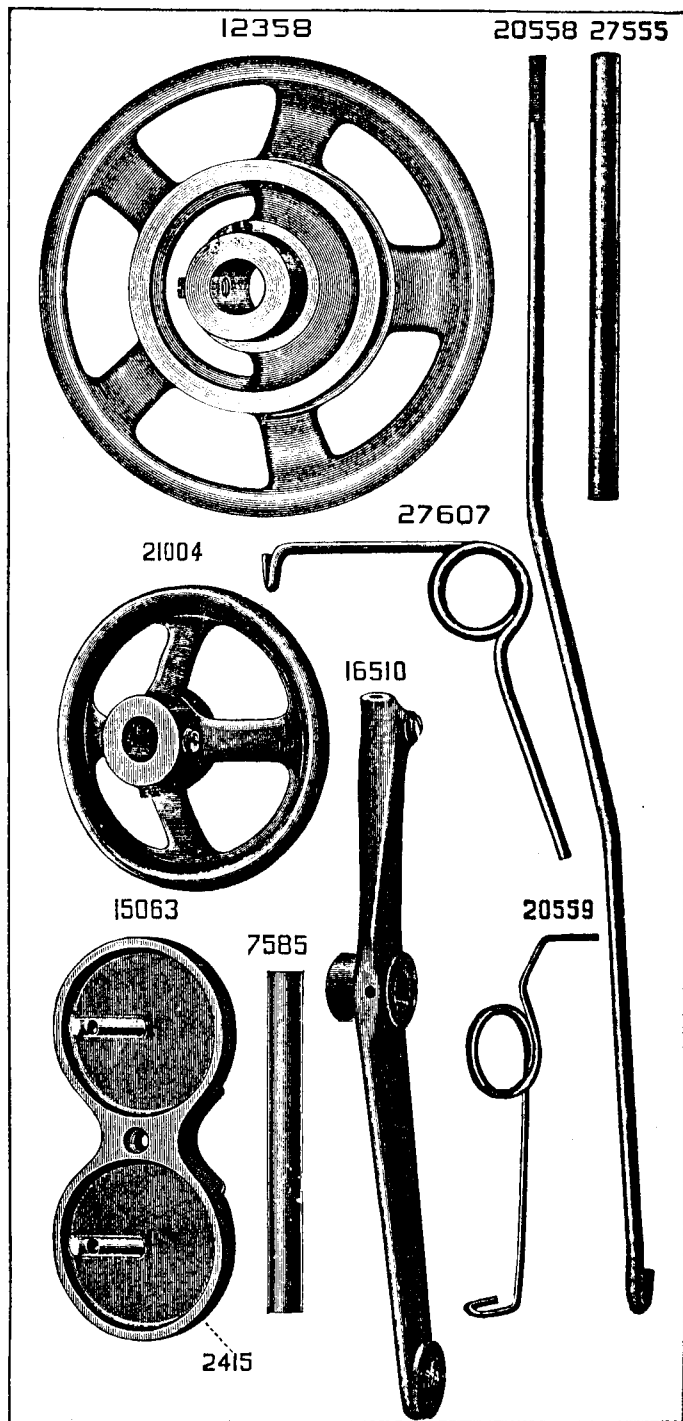


PLATE 1141—ONE-HALF SIZE

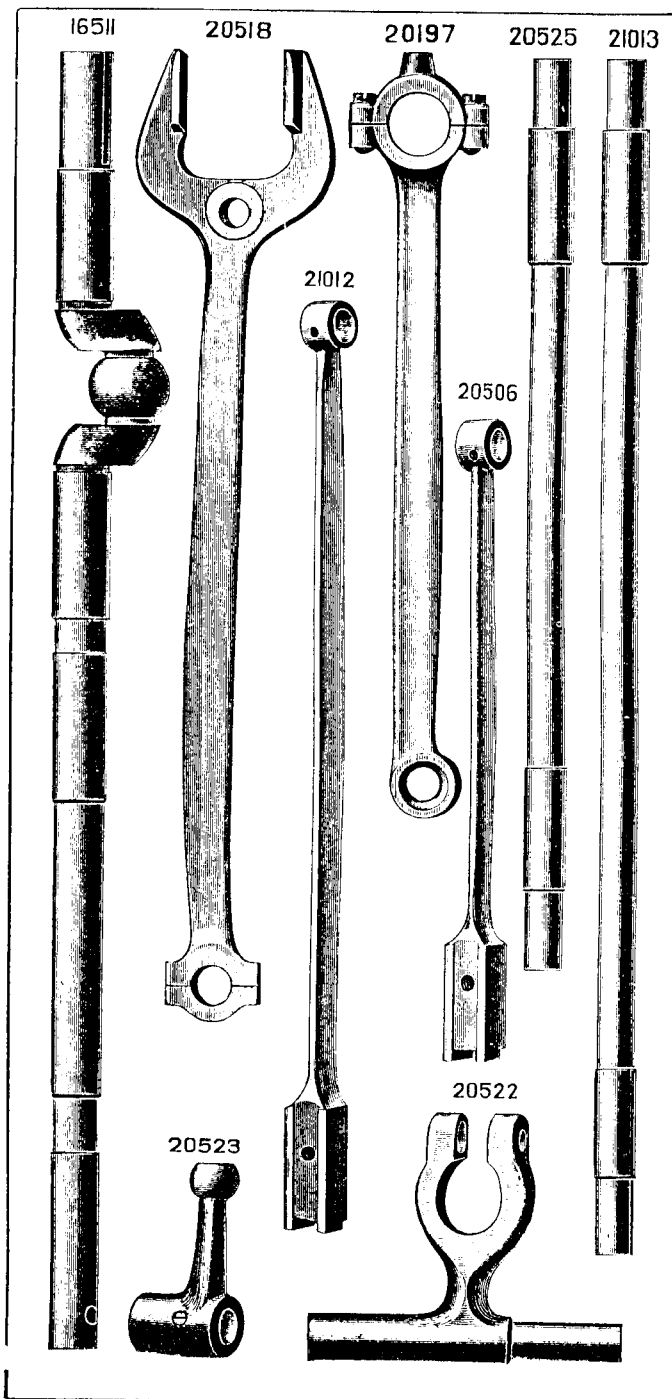


PLATE 1142—ONE-HALF SIZE

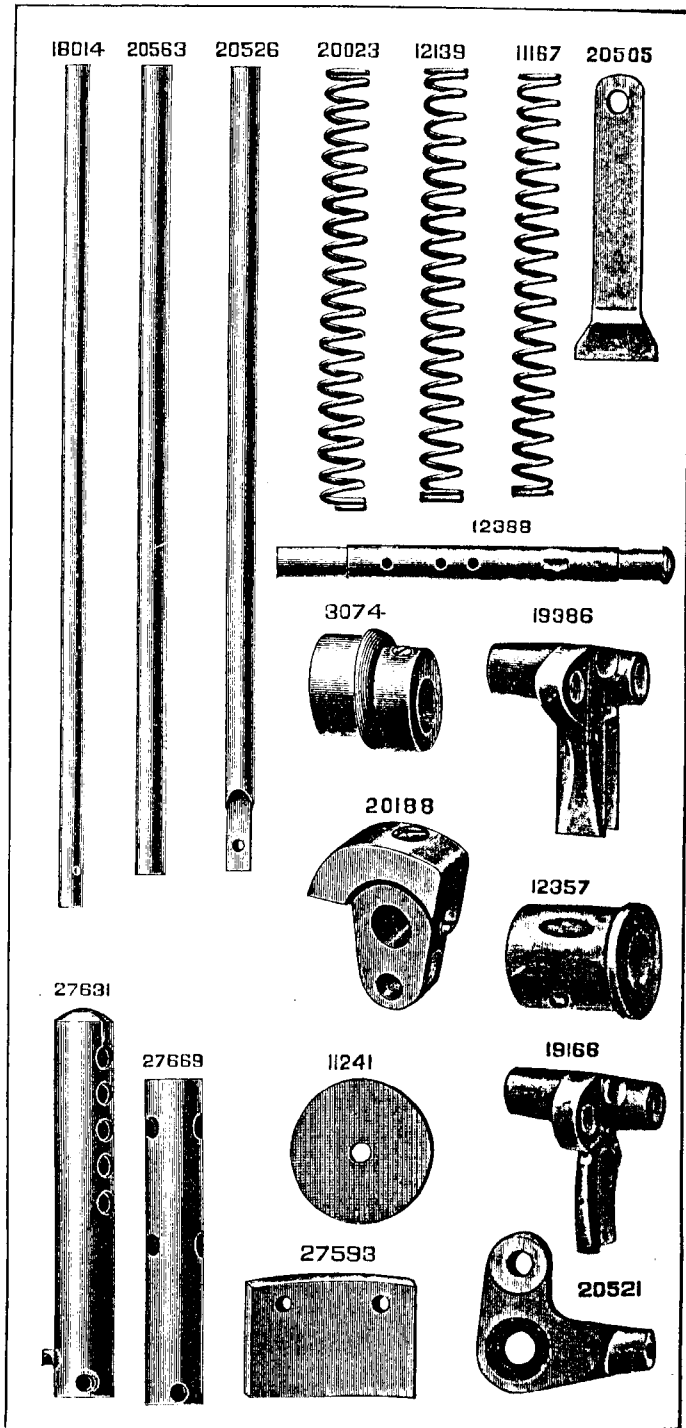


PLATE 1143—ONE-HALF SIZE

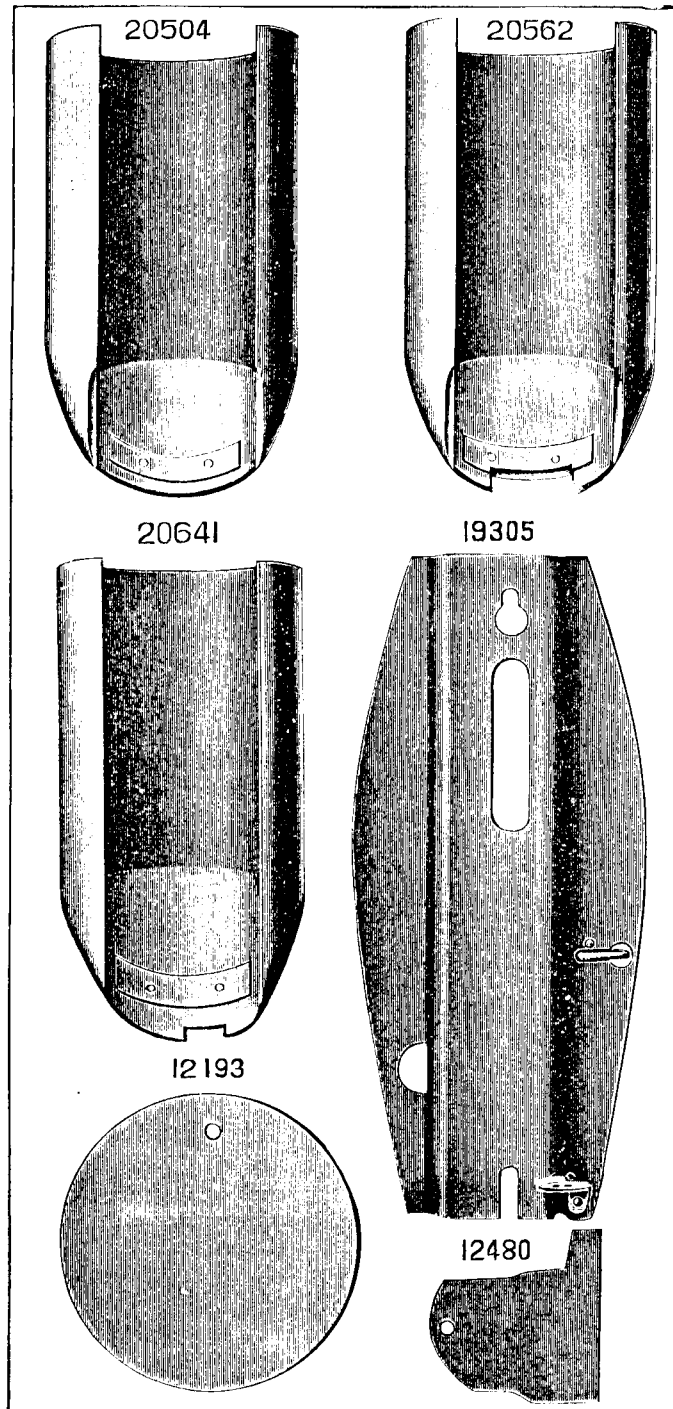


PLATE 1144—FULL SIZE

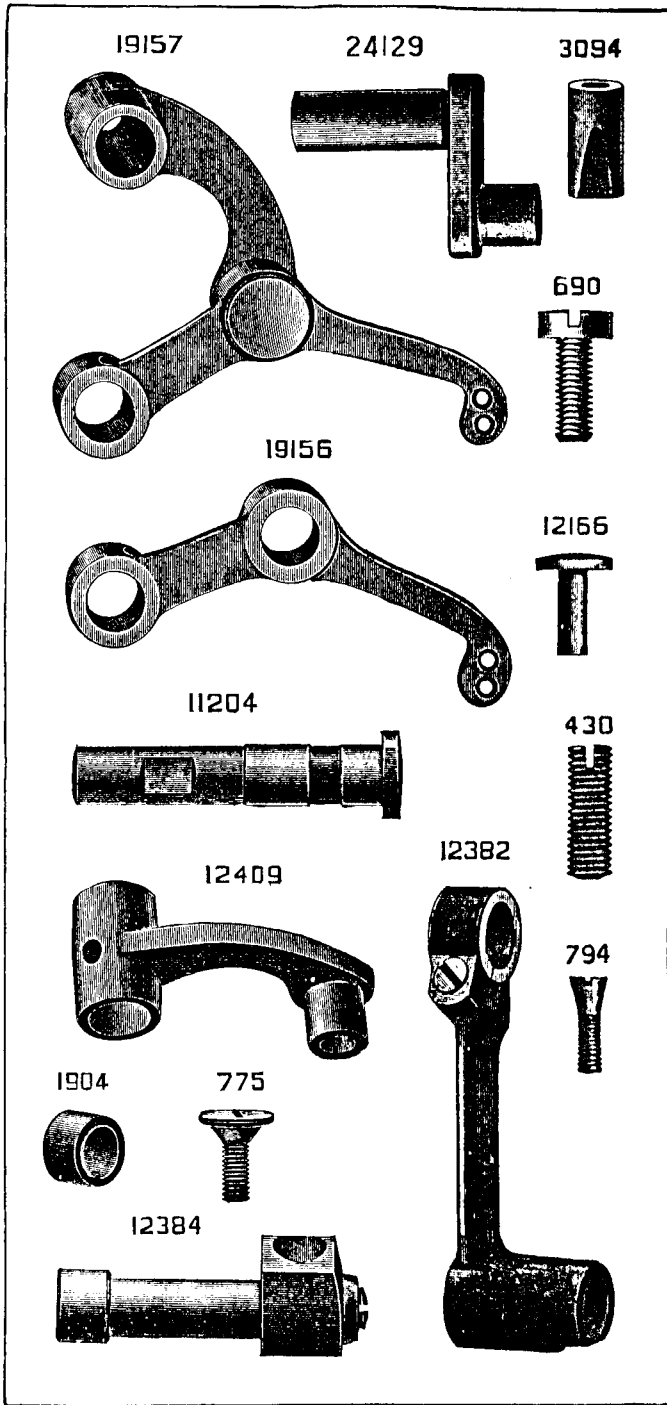


PLATE 1145—FULL SIZE

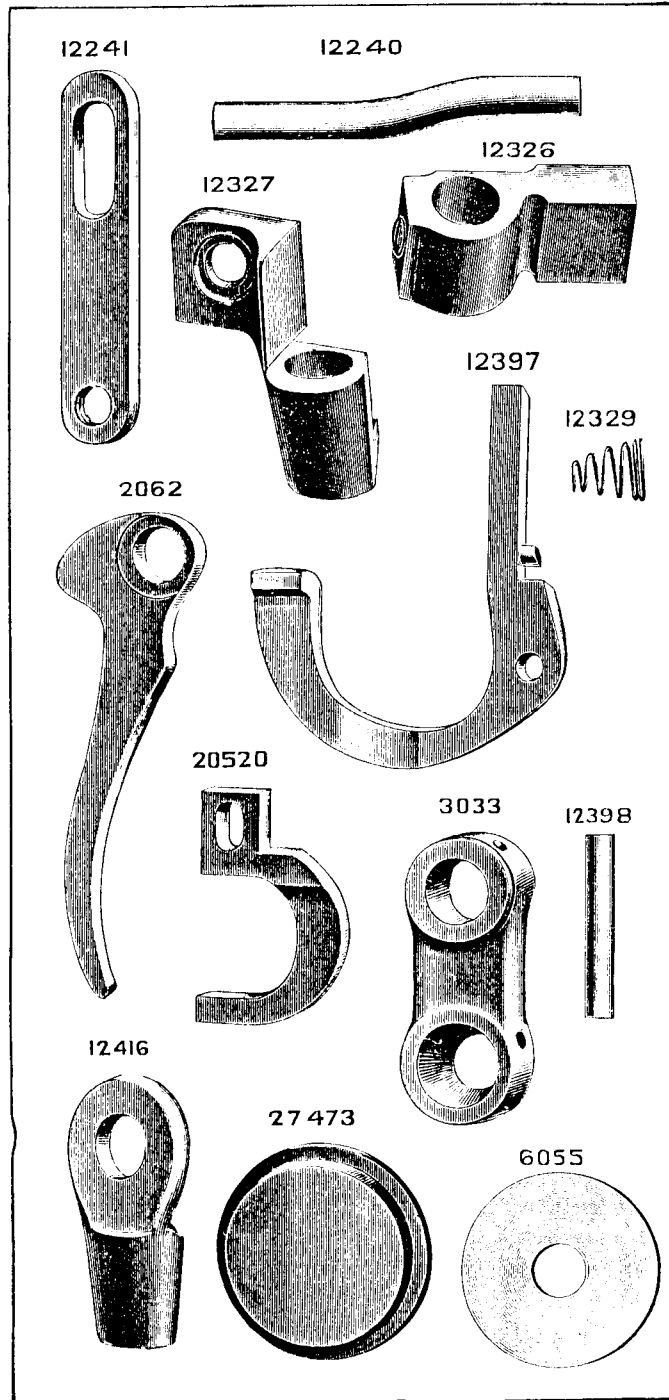


PLATE 1146—FULL SIZE

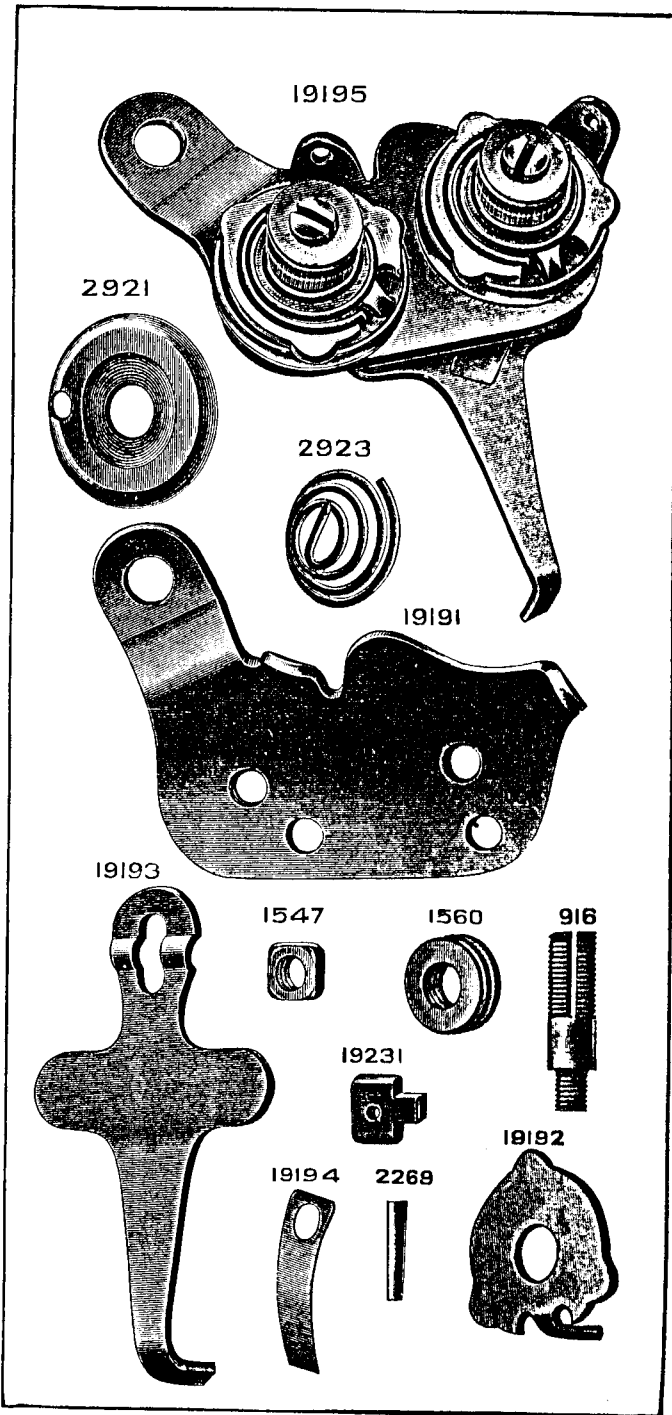


PLATE 1147—FULL SIZE

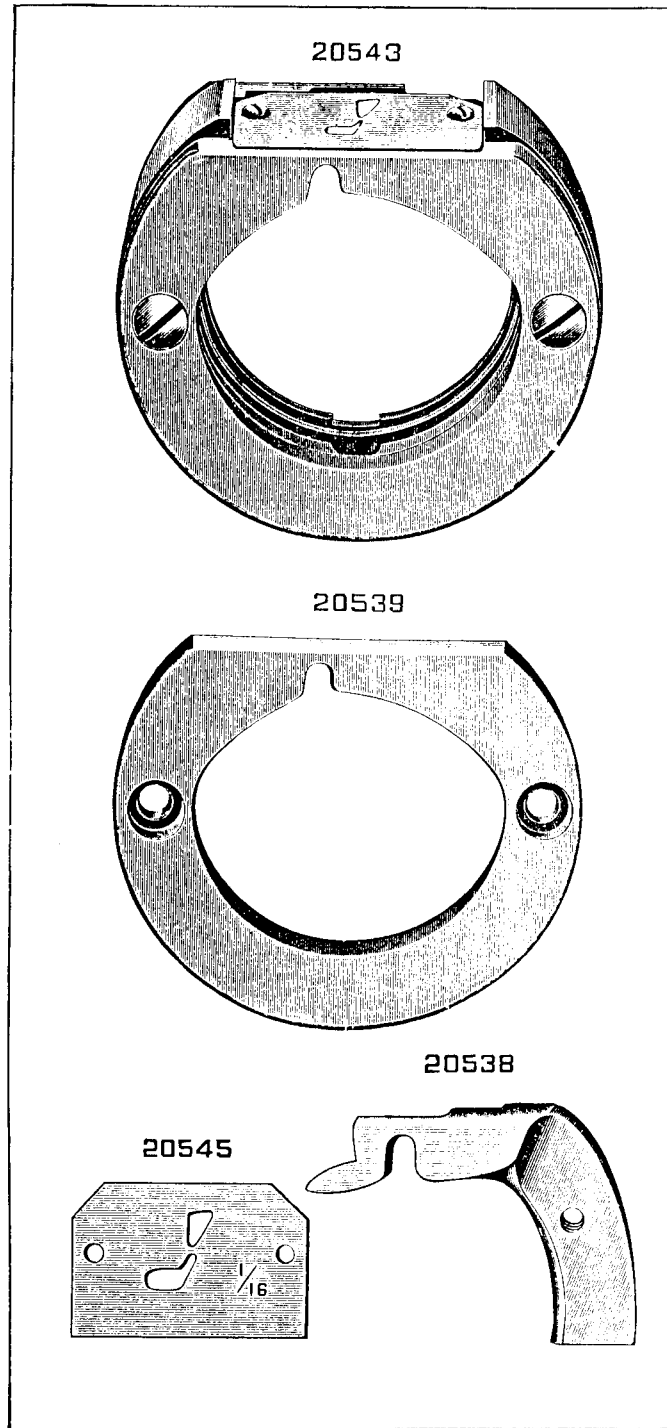


PLATE 1148—FULL SIZE

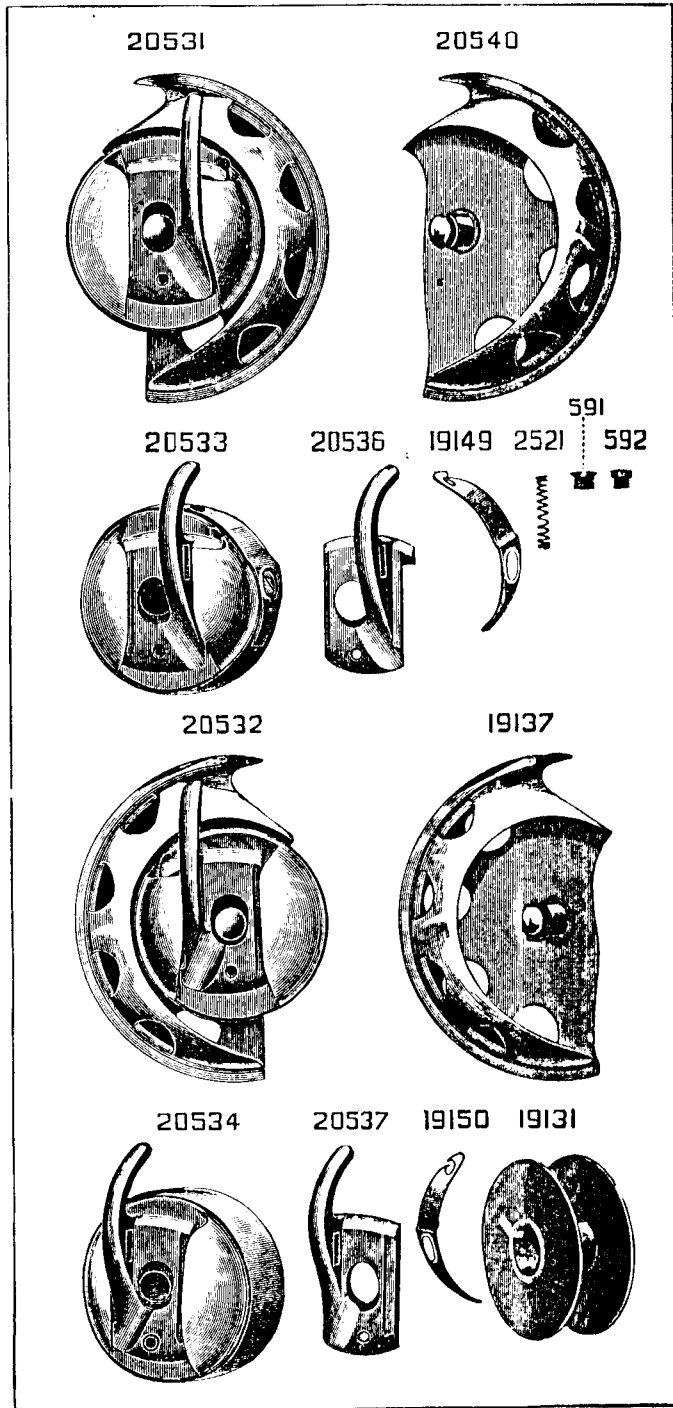


PLATE 1149—FULL SIZE

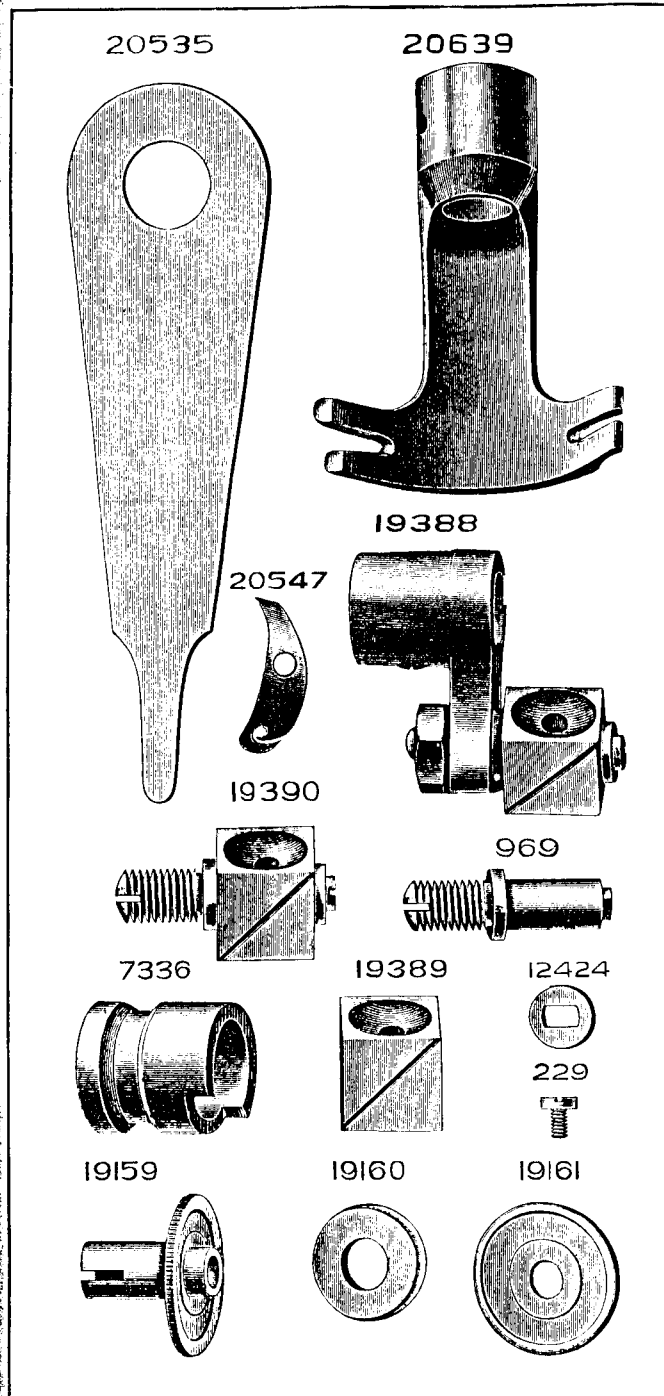


PLATE 1150—FULL SIZE

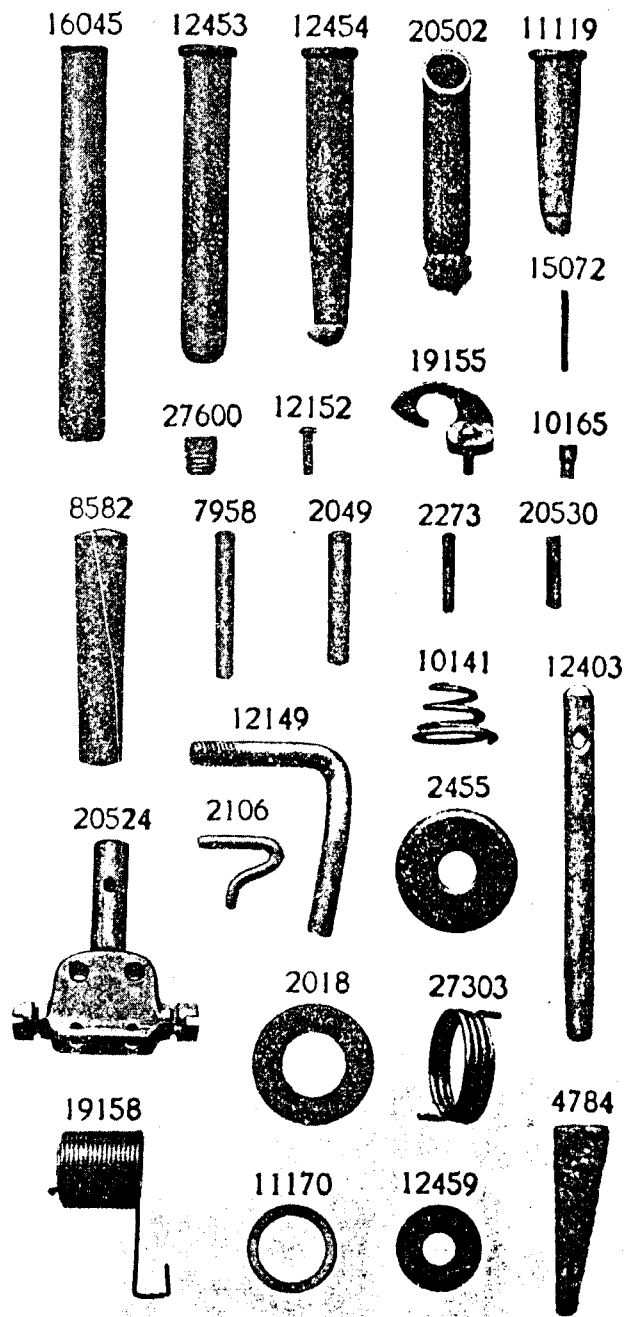
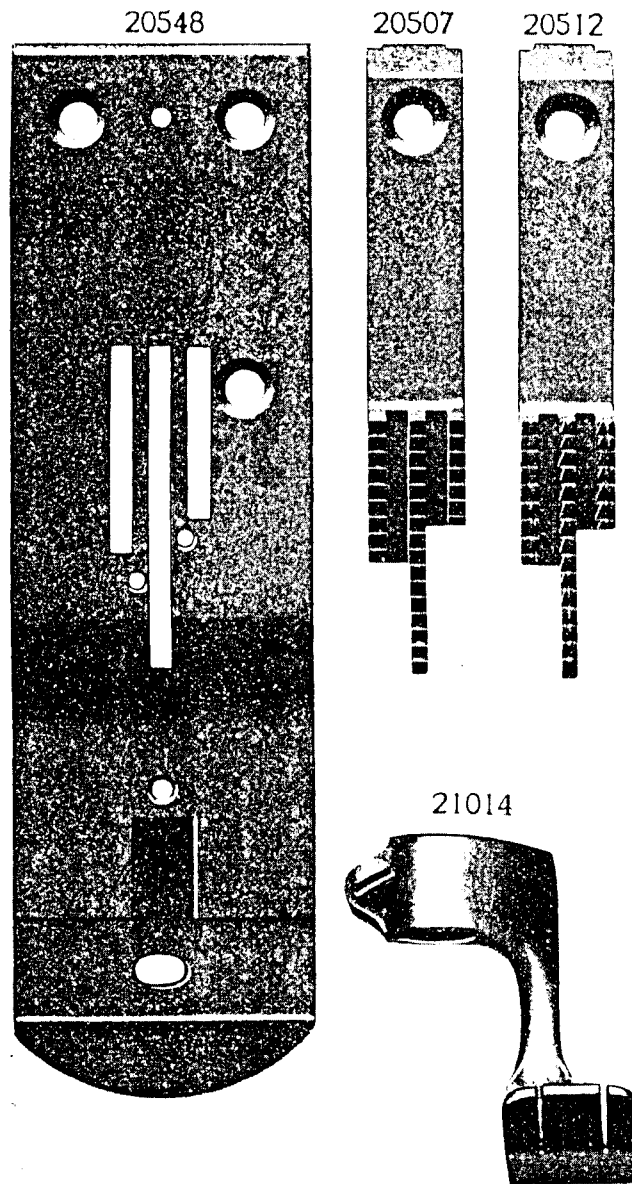


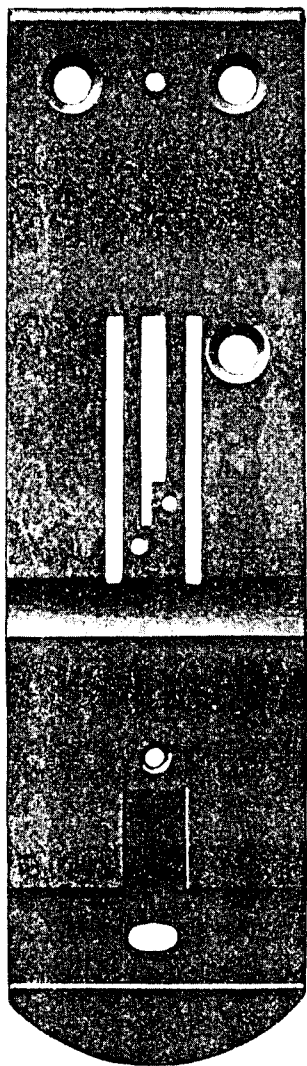
PLATE 1151—FULL SIZE



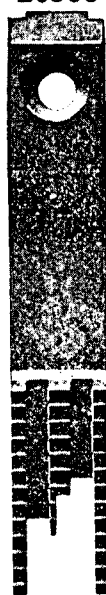
From the library of: Diamond-Needle-Corp.

PLATE 1152—FULL SIZE

20549



20508



20510



20515



20638

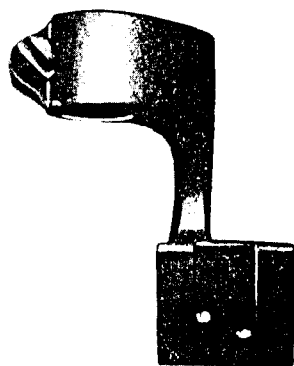
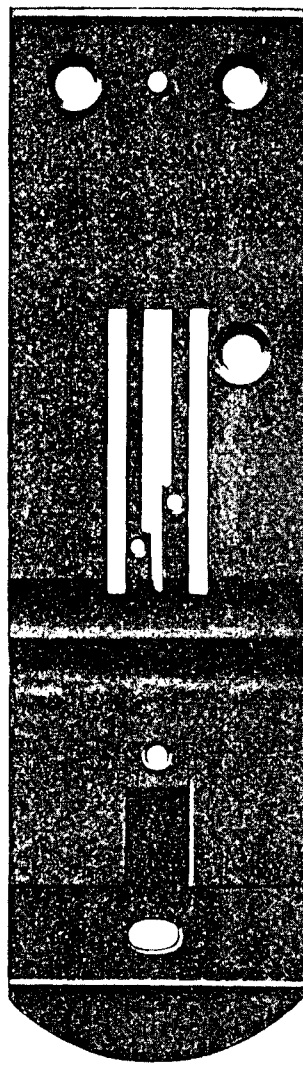
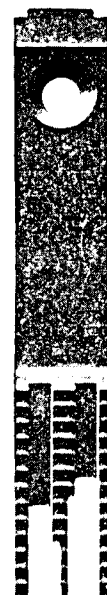


PLATE 1153—FULL SIZE

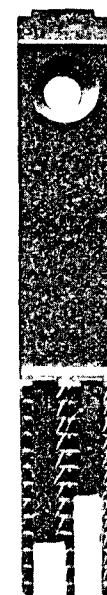
20550



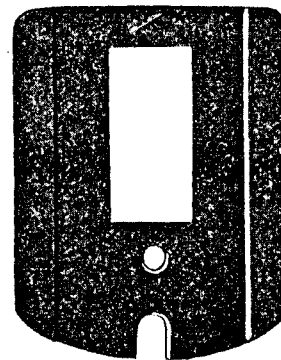
20509



20511



26277

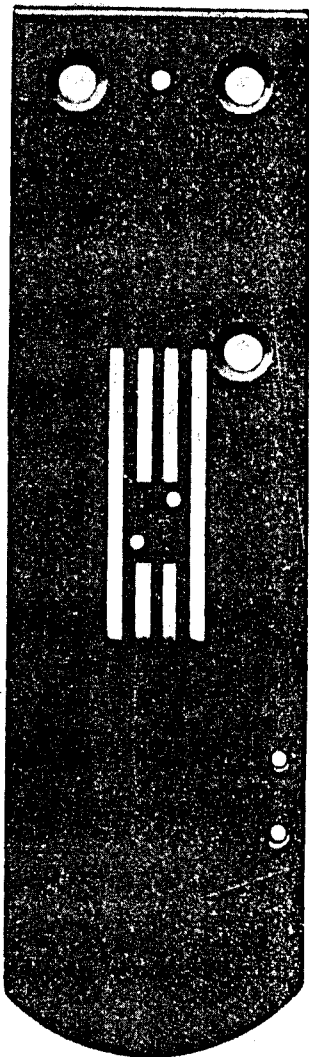


19294

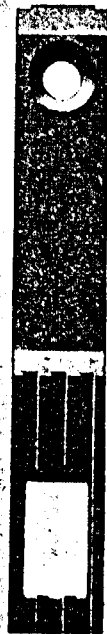


PLATE 1154—FULL SIZE

20551



20513



20643

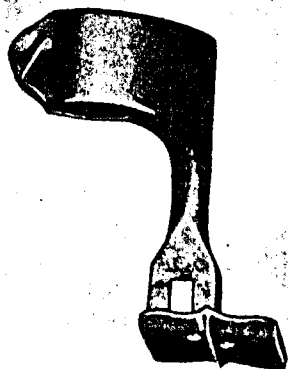
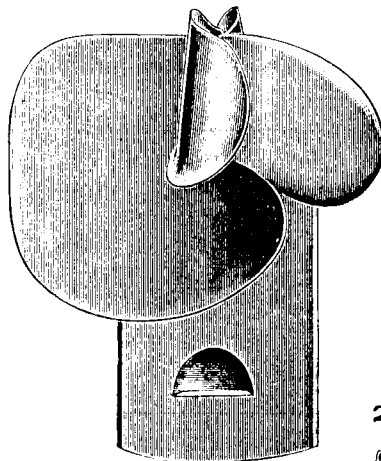
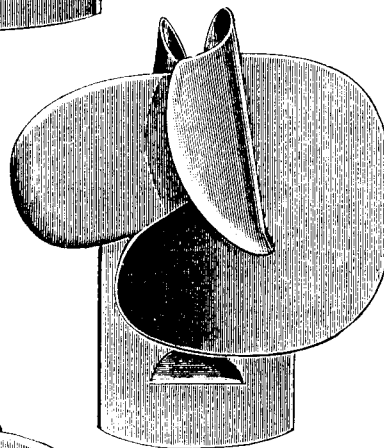


PLATE 1155—FULL SIZE

26353



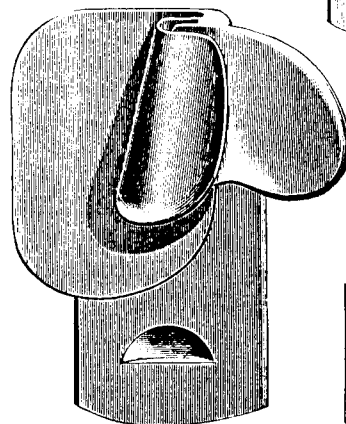
26390



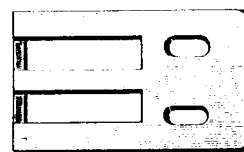
26384



26392



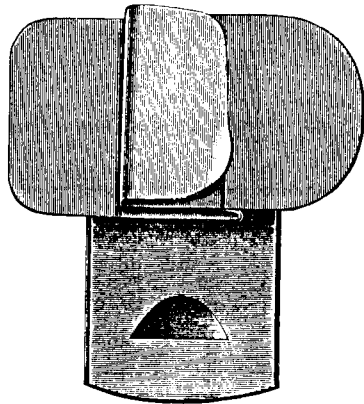
26385



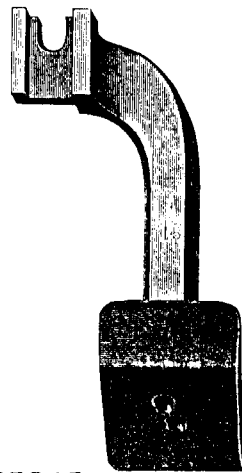
From the library of: Diamond Needle Corp

PLATE 1156—FULL SIZE

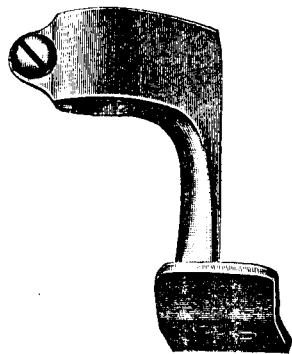
26394



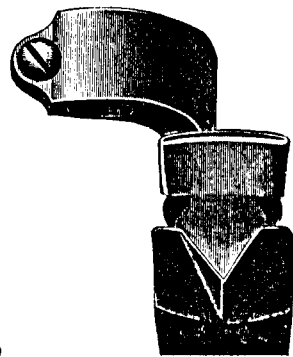
20527



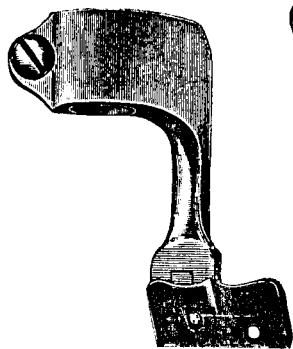
21017



20648



20646



20682

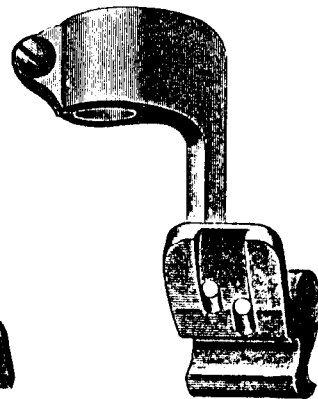
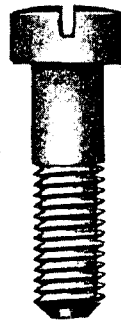


PLATE 1157—FULL SIZE

748



905



131



138



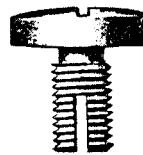
134



935



144



157



896



159



704



175



190



209



219



802



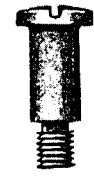
689



32



35



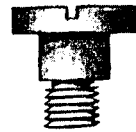
766



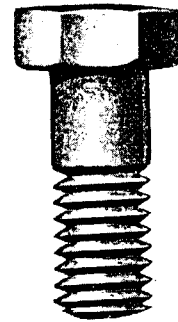
76



58



868



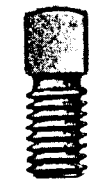
597



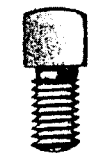
354



356



362



955



PLATE 1158—FULL SIZE

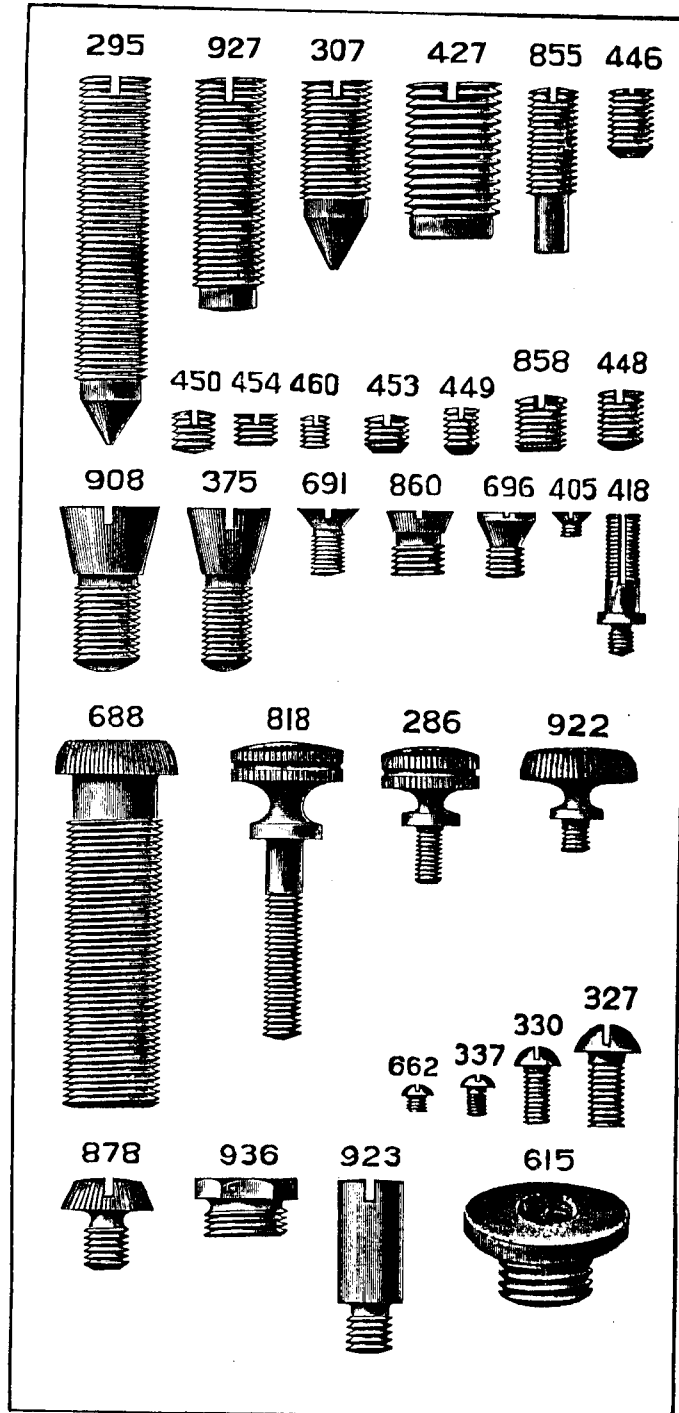


PLATE 1159—FULL SIZE

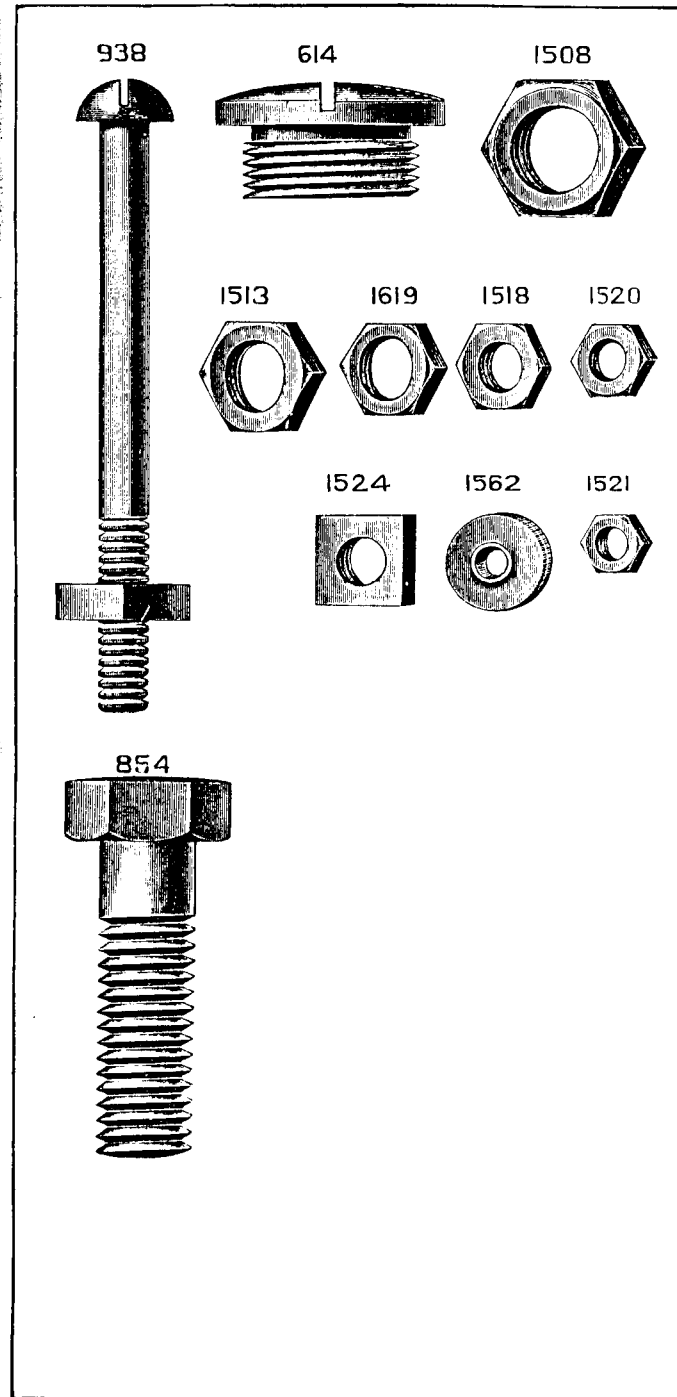


PLATE 1160—FULL SIZE

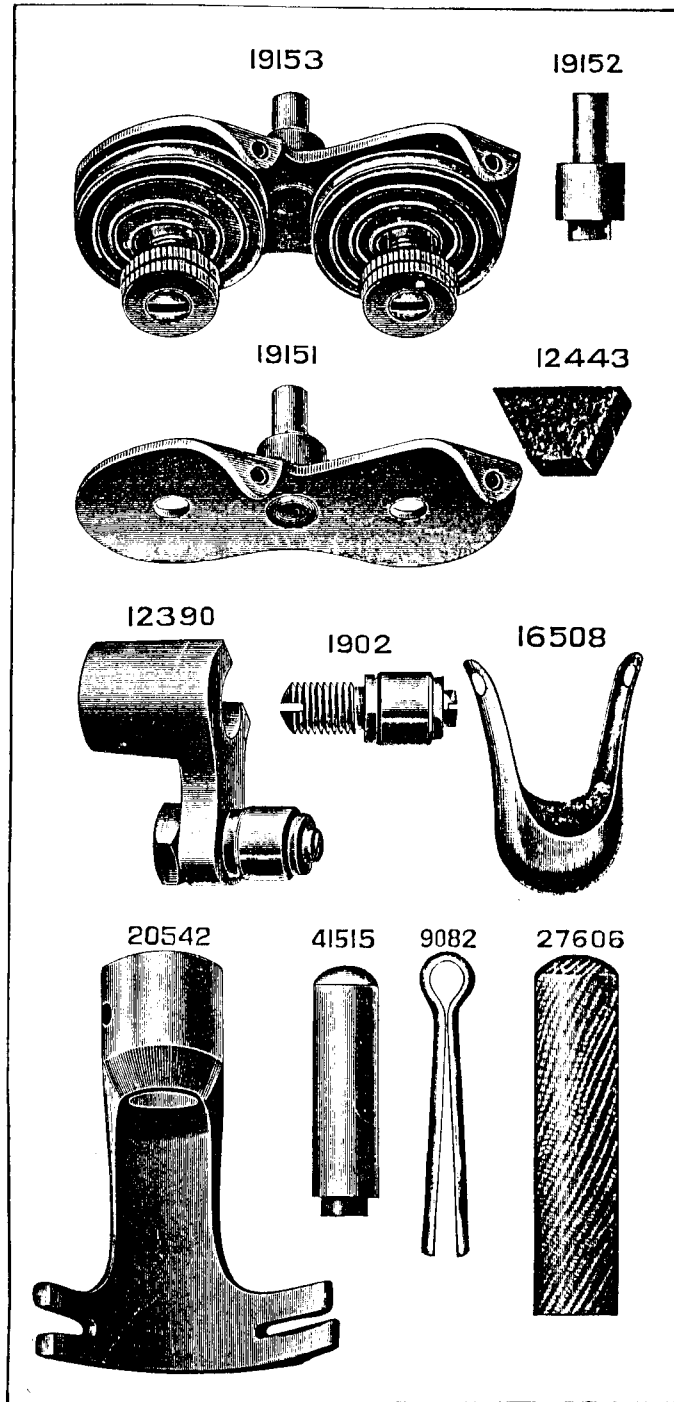


PLATE 1161—ONE-HALF SIZE

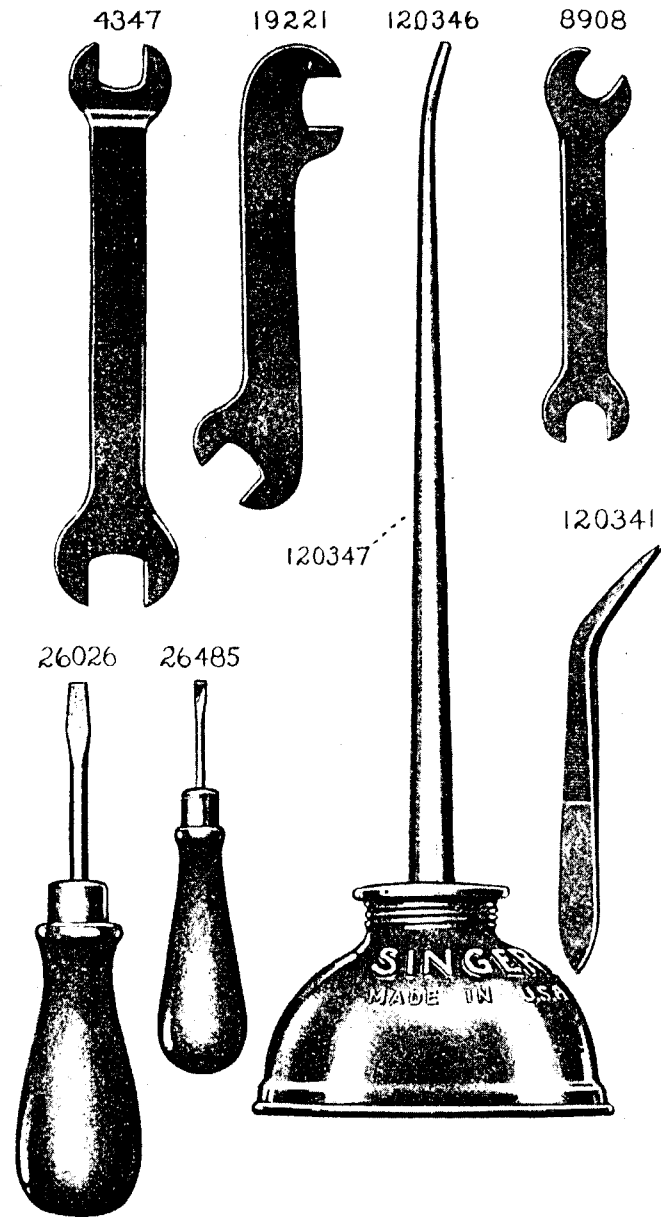


PLATE 1162—ONE-HALF SIZE

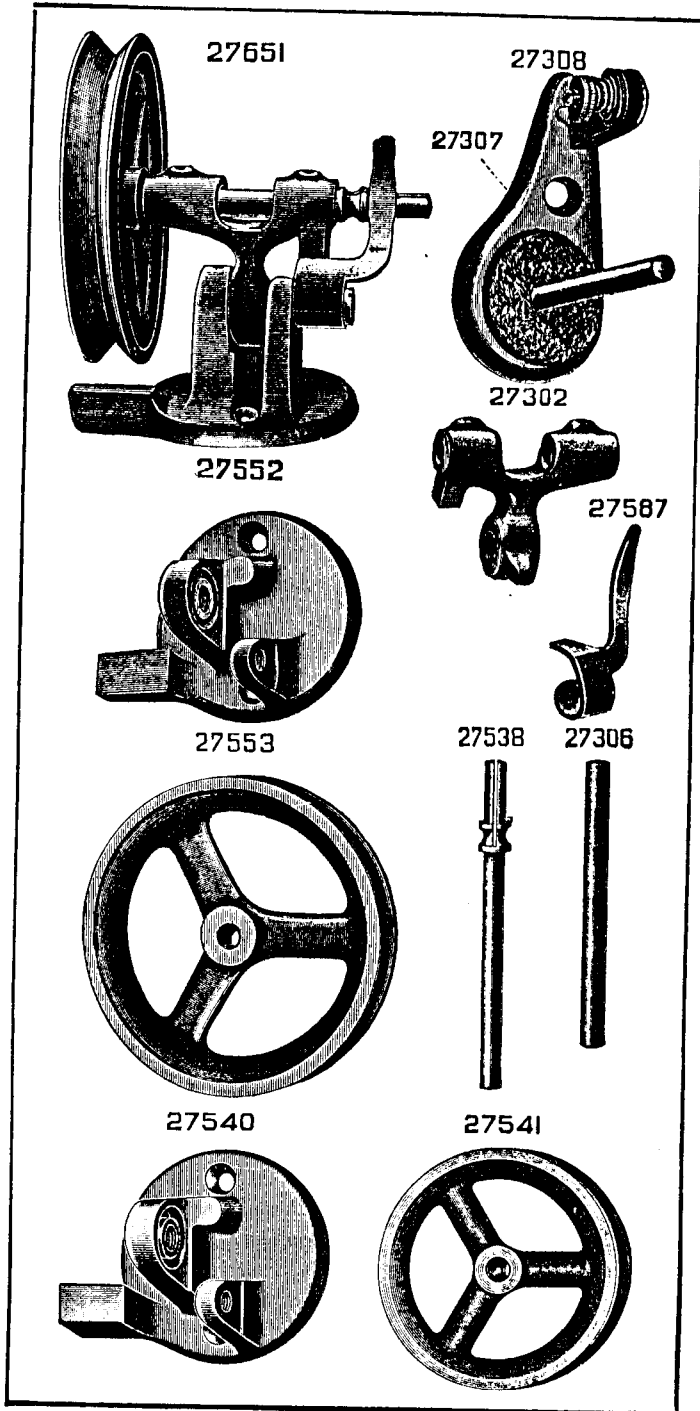


PLATE 1164—ONE-FOURTH SIZE

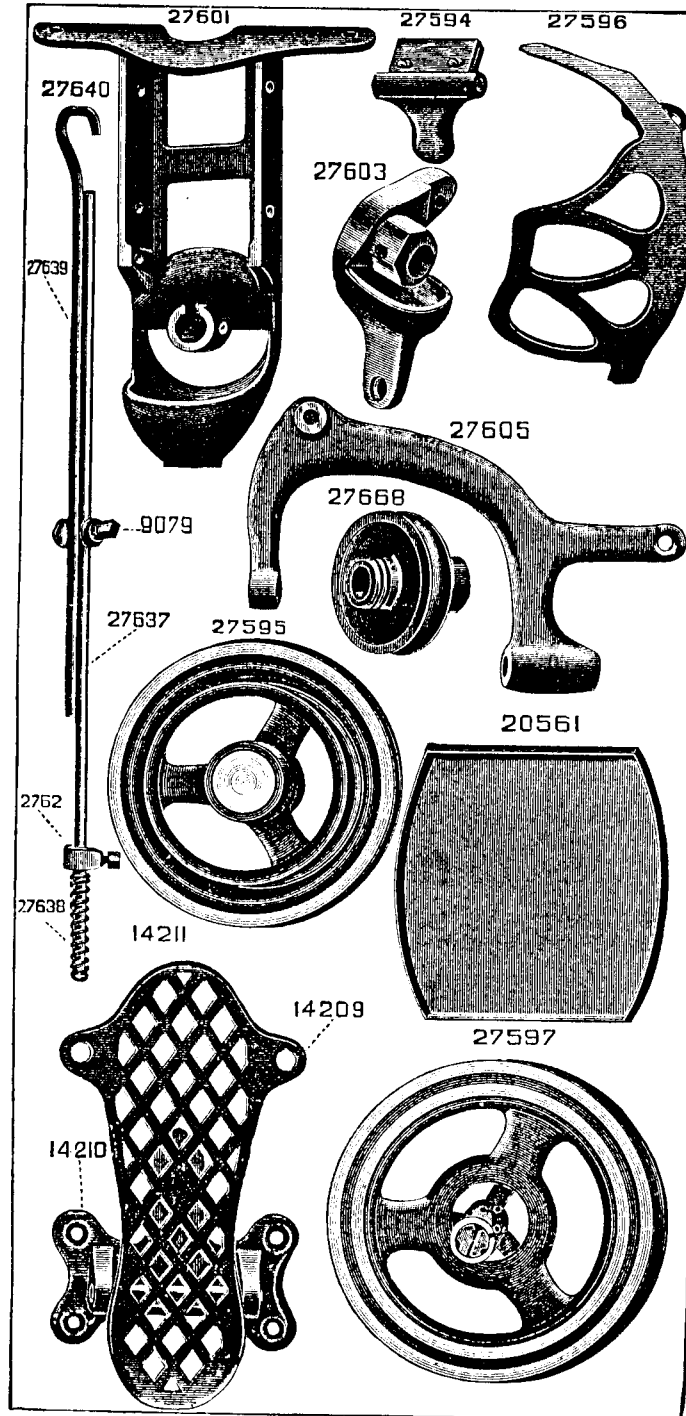


PLATE 1166—FULL SIZE

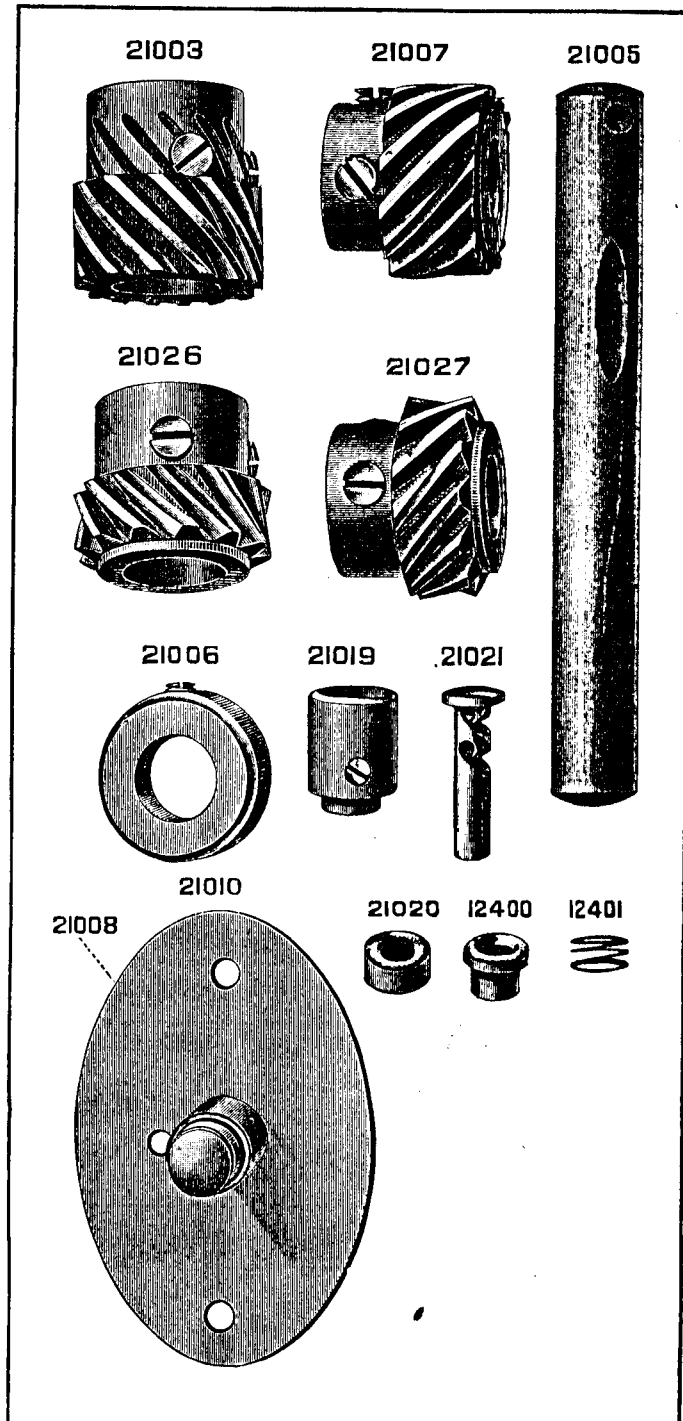


PLATE 1167—ONE-FOURTH SIZE

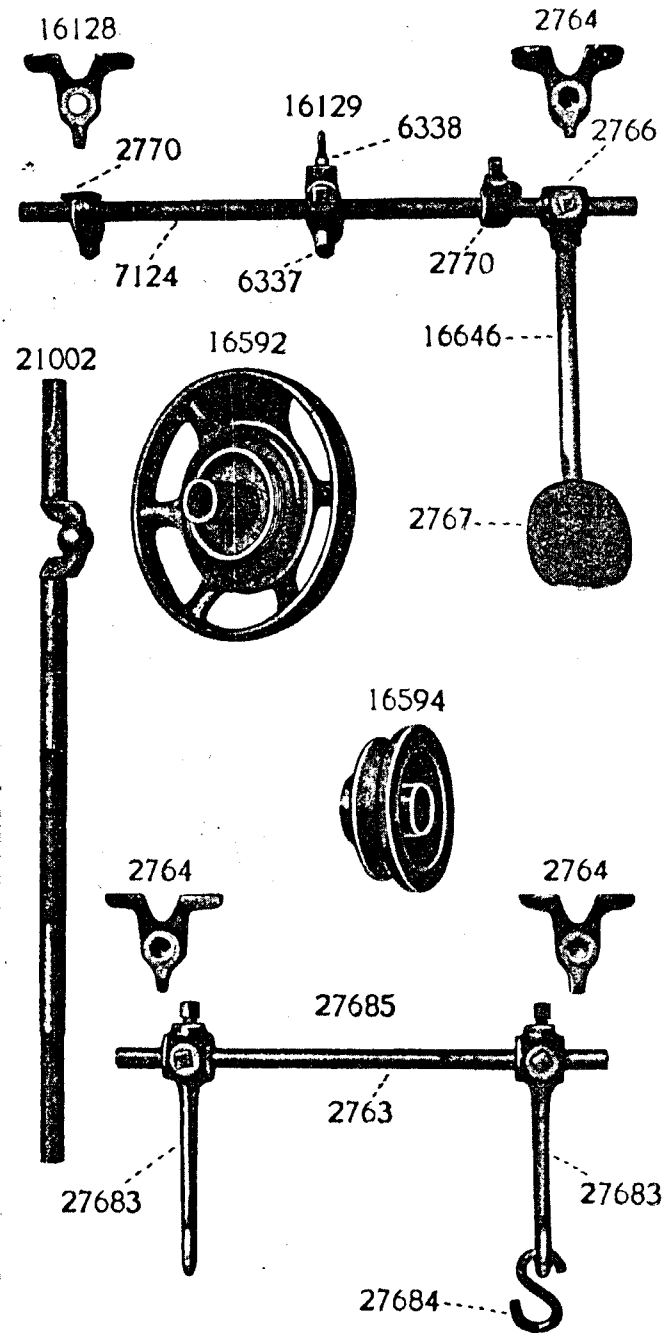
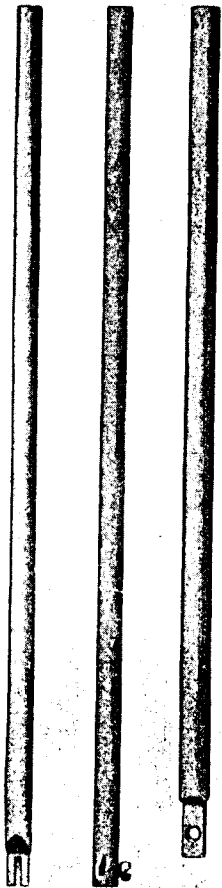
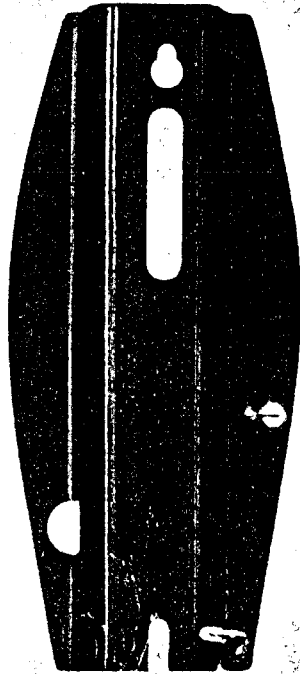


PLATE 1170—ONE-HALF SIZE

12381 21041 12391



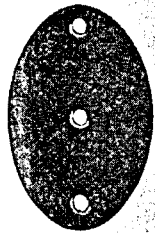
12367



24355



21023

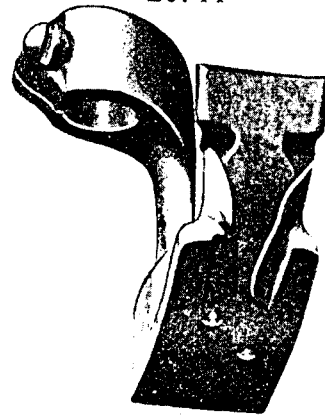


14231

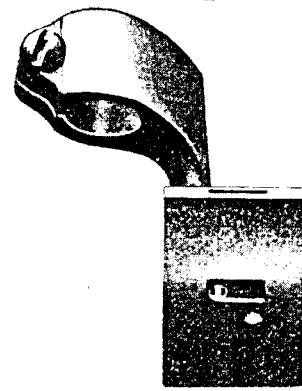


PLATE 1171—FULL SIZE

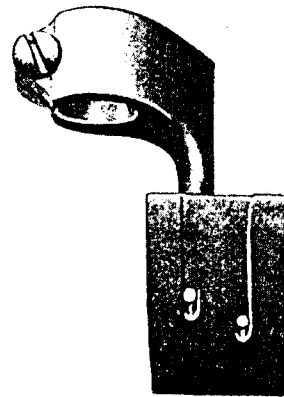
20711



20712



20761



20754

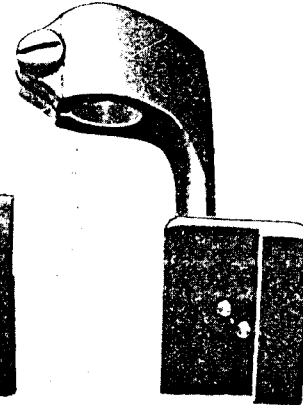
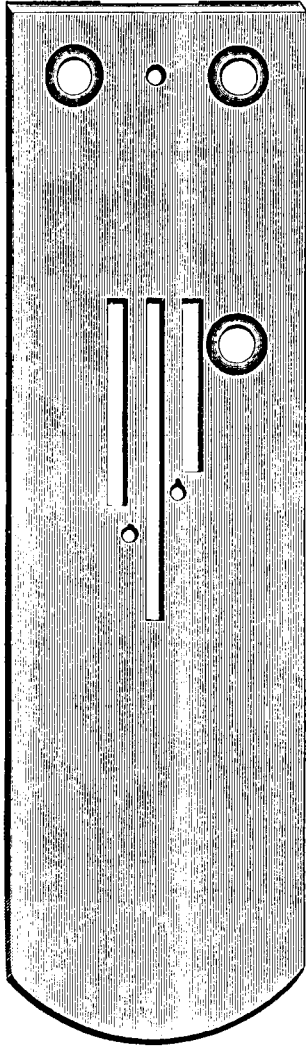


PLATE 1175—FULL SIZE

20552



20514

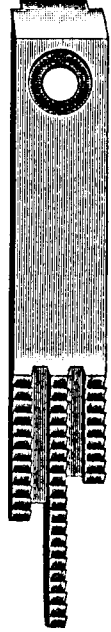
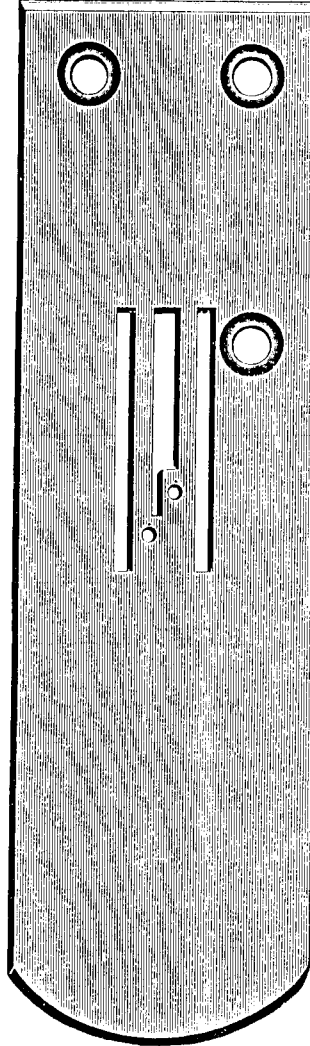


PLATE 1176—FULL SIZE

20553



20554

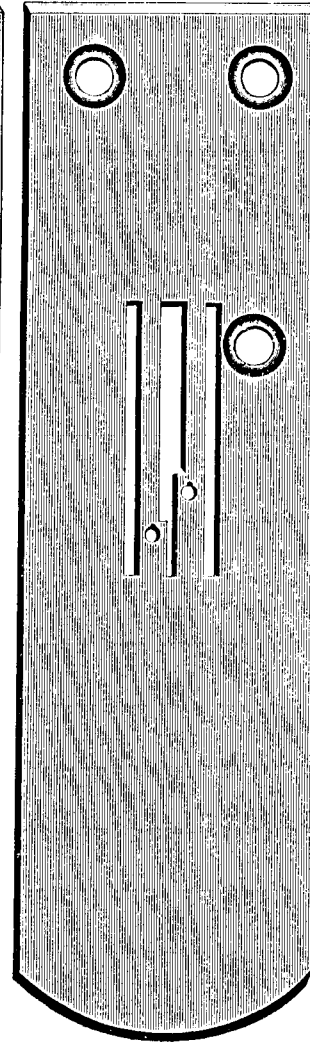
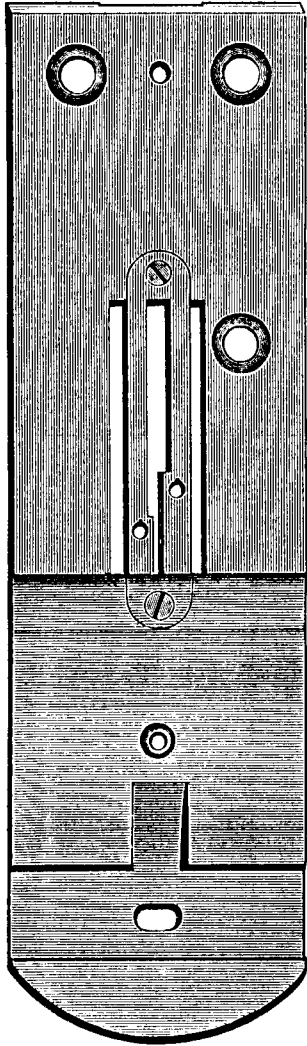


PLATE 1177—FULL SIZE

20556

20688 1053

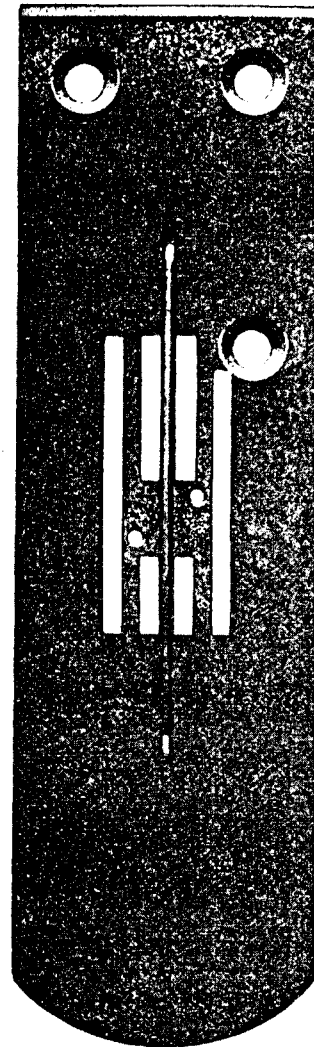
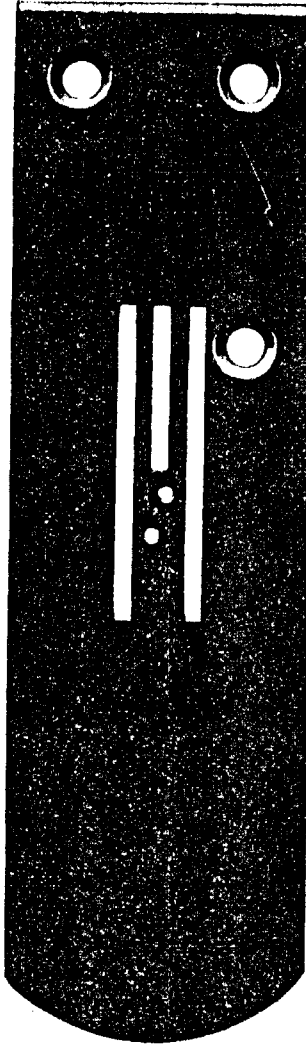


1053

PLATE 1178—FULL SIZE

20751

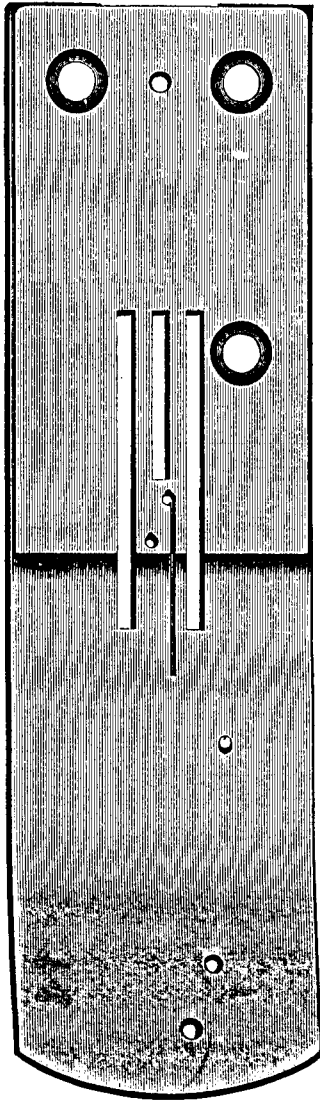
20557



From the library of: Diamond Needle Corp

PLATE 1179—FULL SIZE

20632

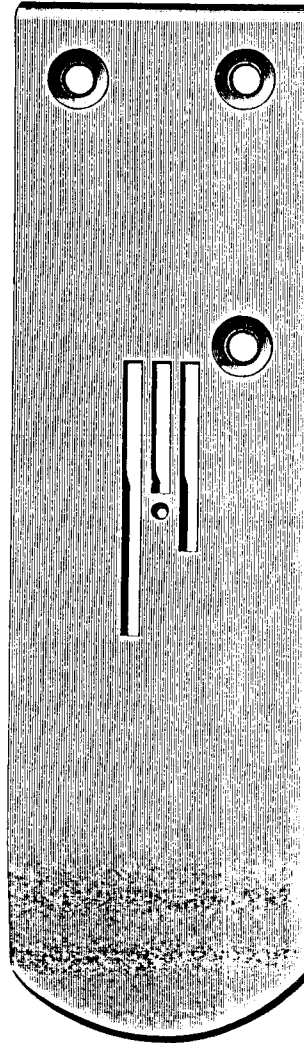


20630



PLATE 1189—FULL SIZE

20657

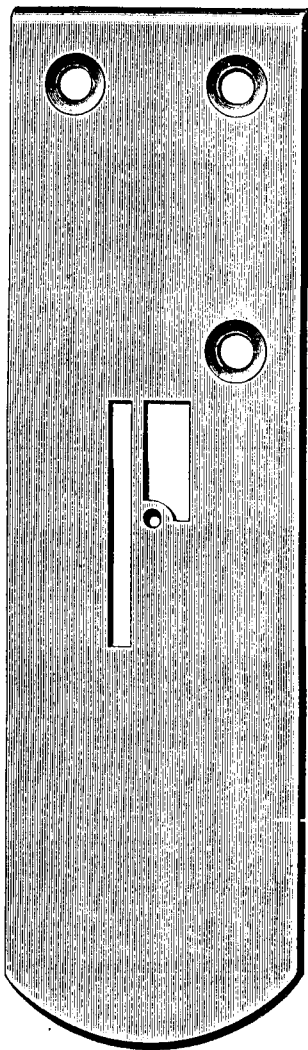


20656



PLATE 1190—FULL SIZE

20663

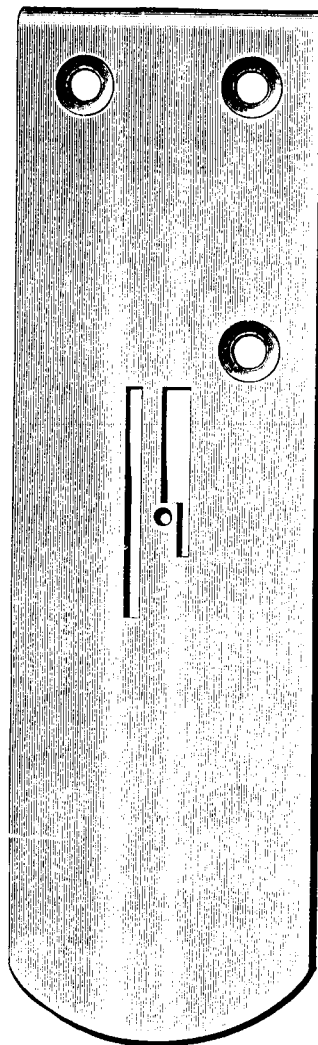


20662



PLATE 1191—FULL SIZE

20665



20664



From the library of: Diamond Needle Corp

PLATE 1193—FULL SIZE

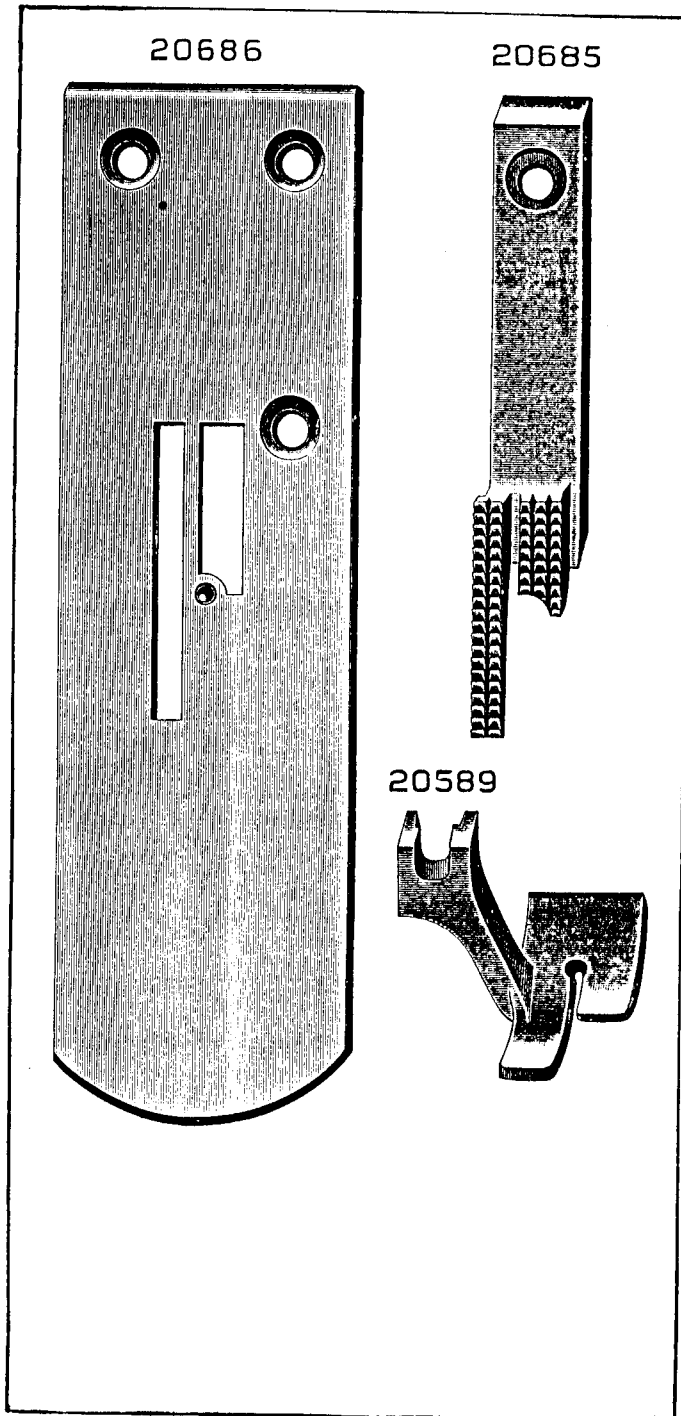
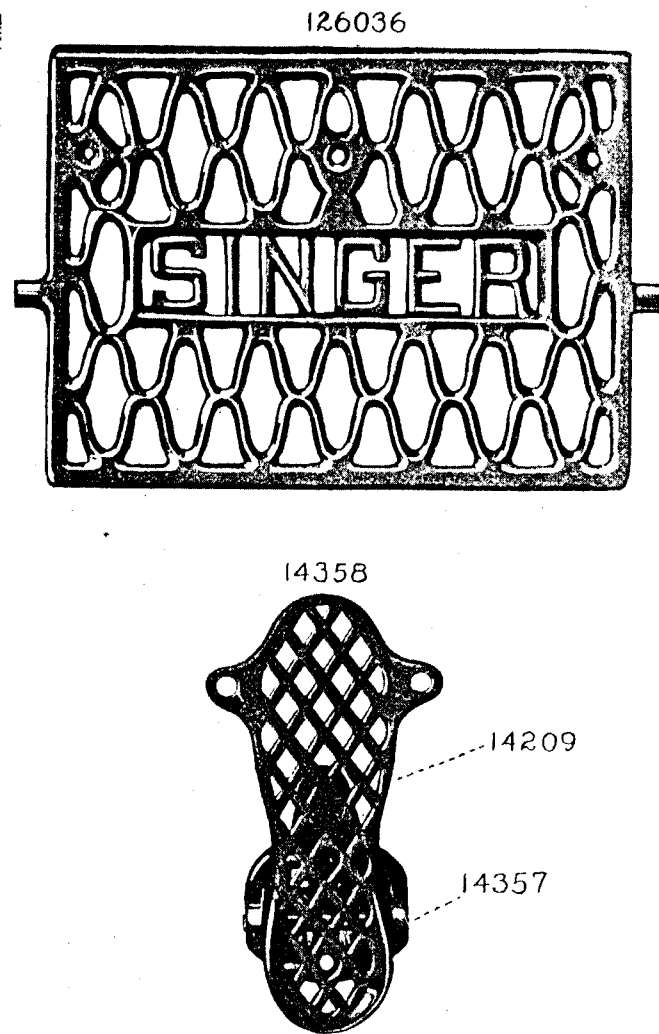


PLATE 3477—ONE-FOURTH SIZE



From the library of: Diamond Needle Corp

PLATE 4314—ONE-HALF SIZE

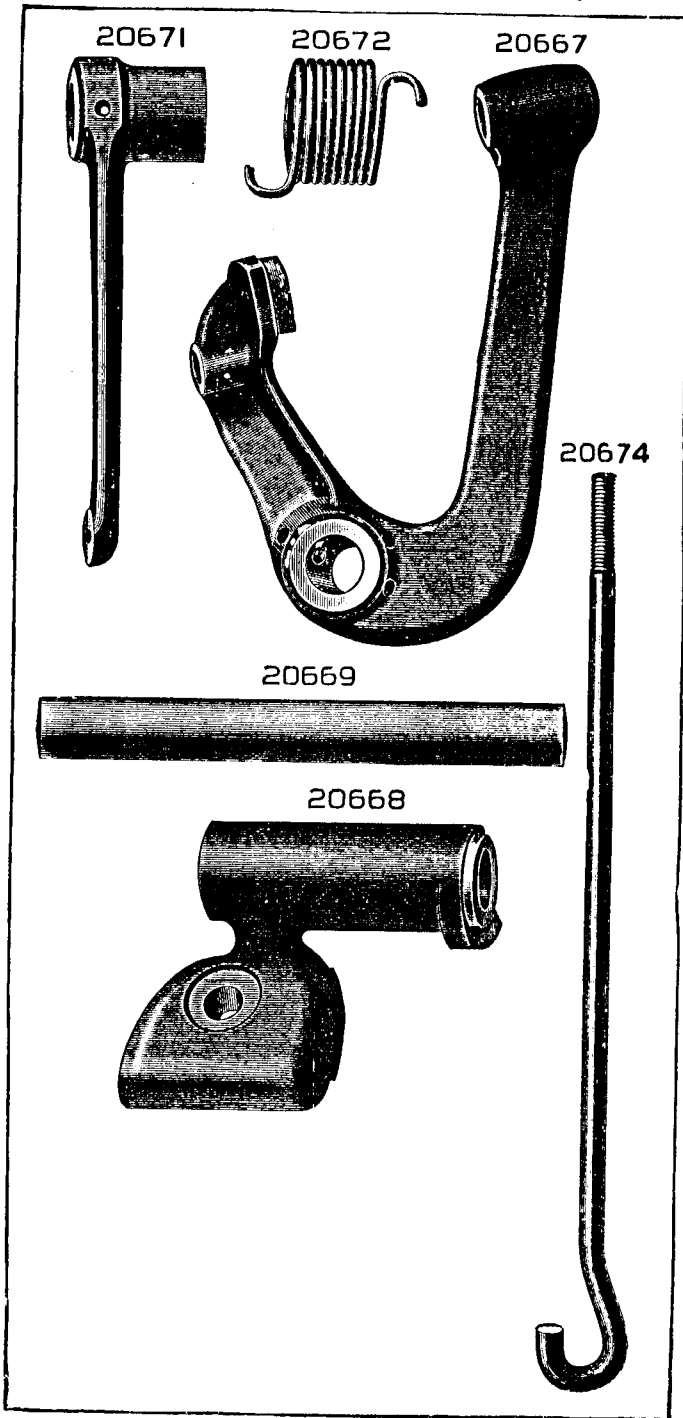


PLATE 4320—FULL SIZE

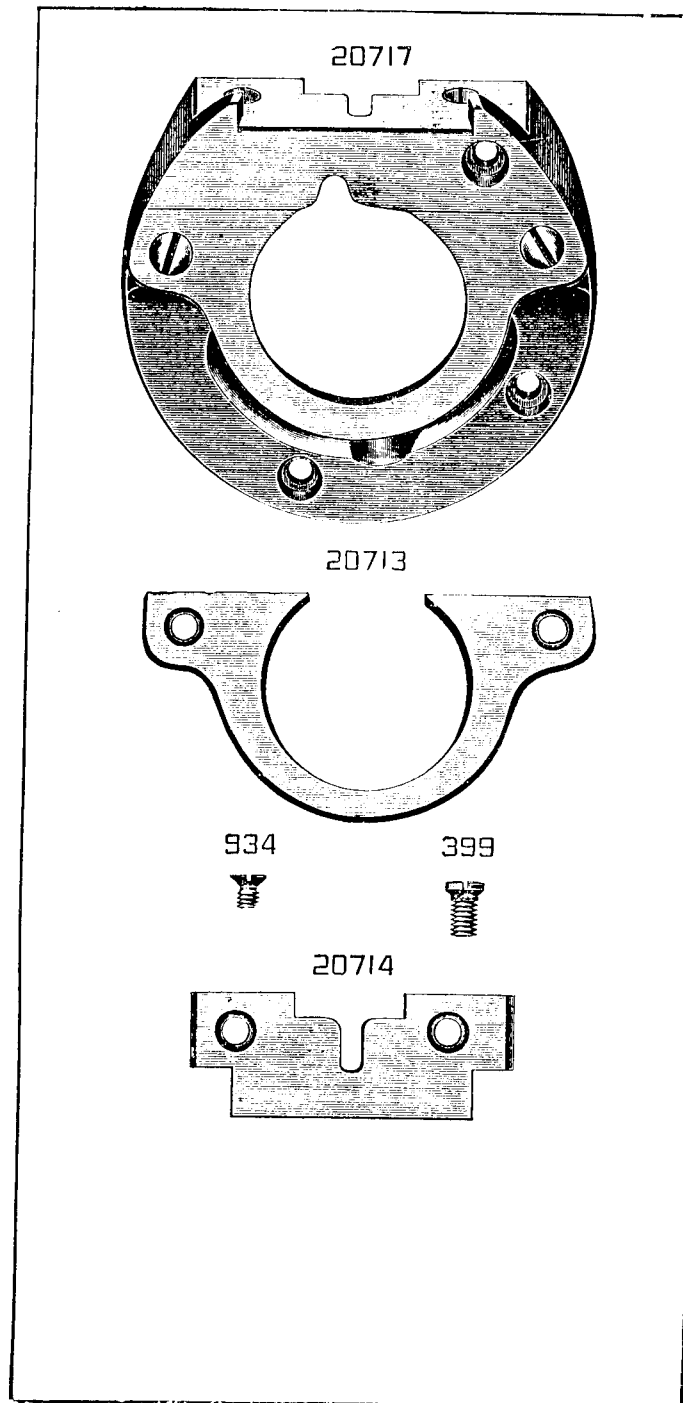
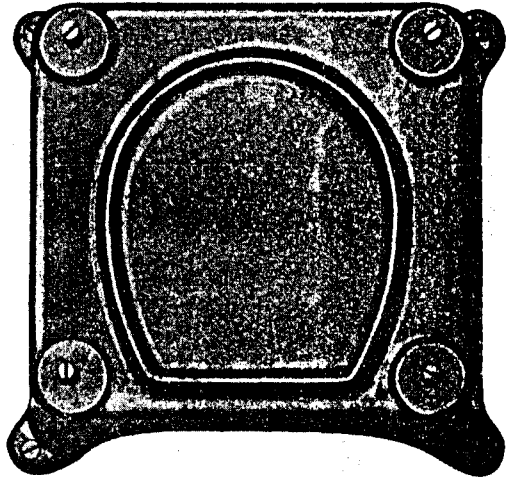
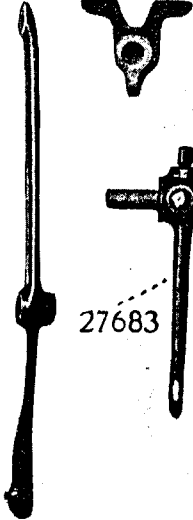


PLATE 4321—ONE-FOURTH SIZE

20747



12237 2764



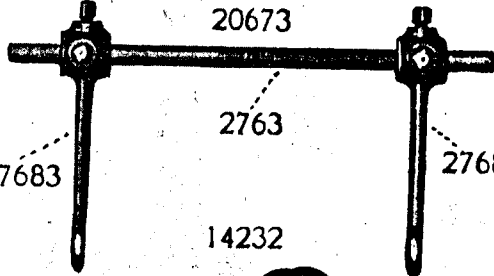
27683



2764



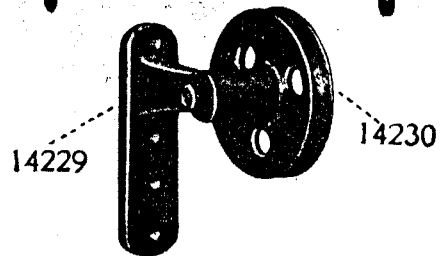
20673



2763

27683

14232

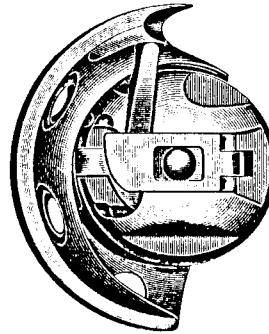


14229

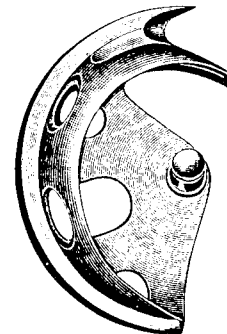
14230

PLATE 5737—FULL SIZE

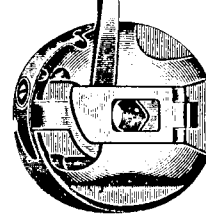
20758



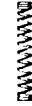
20757



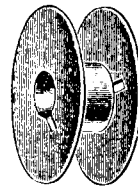
20756



20755 2523 2975 592



19131



20649



2973



2974 591



20654



PLATE 7233—ONE-SIXTH SIZE

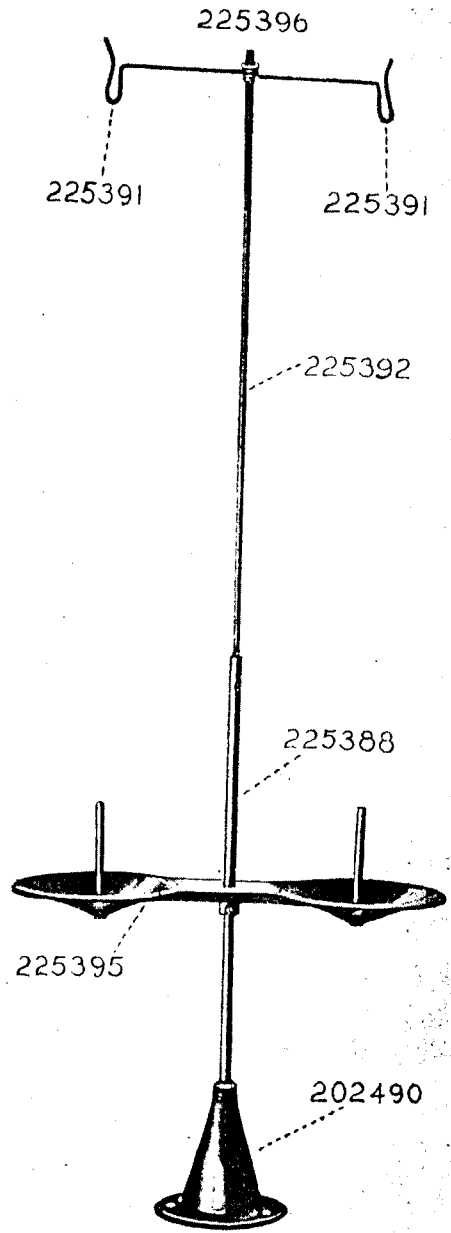


PLATE 7234—ONE-HALF SIZE

27739



225390

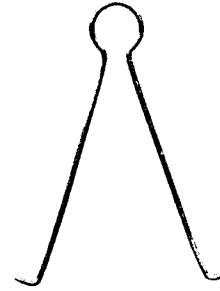
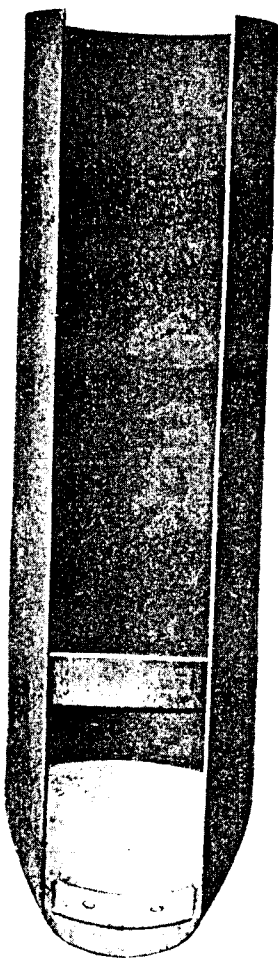


PLATE 7425—ONE-HALF SIZE

21040



21044

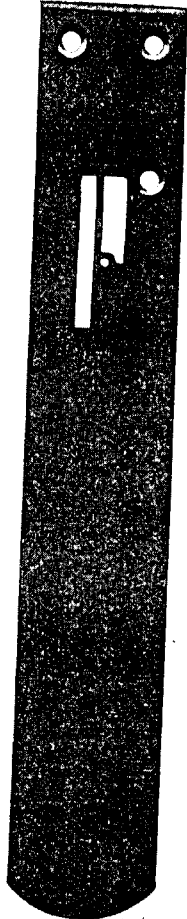


PLATE 7426—FULL SIZE

19336



20625

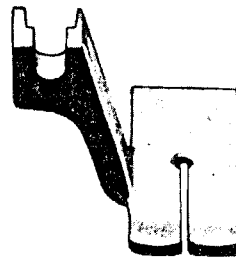
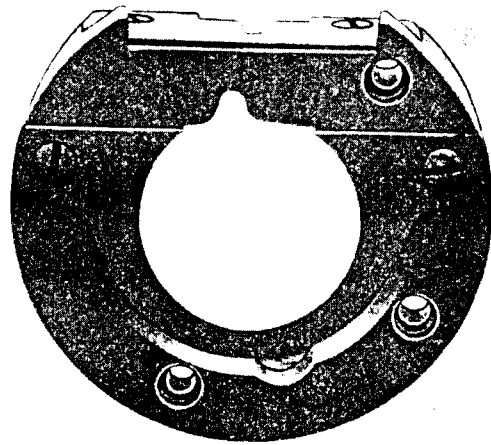
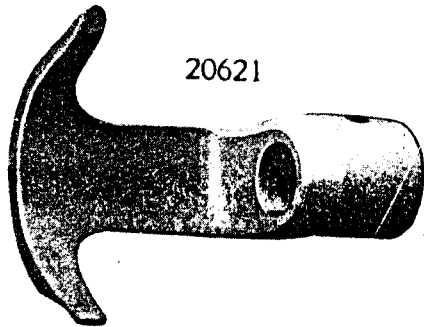


PLATE 7427—FULL SIZE

20718



20621



20750

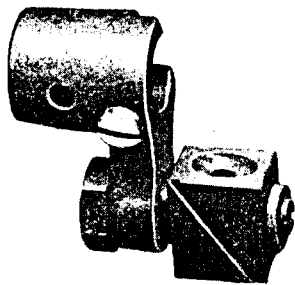
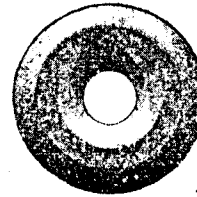


PLATE 7428—FULL SIZE

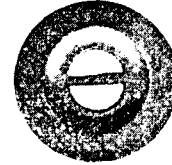
50327



2102



32572



32574



43945



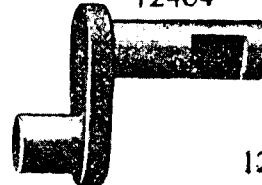
21037 52378



210992



12404



210958



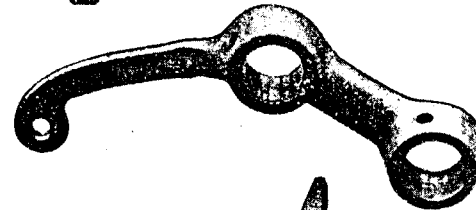
210993



52398



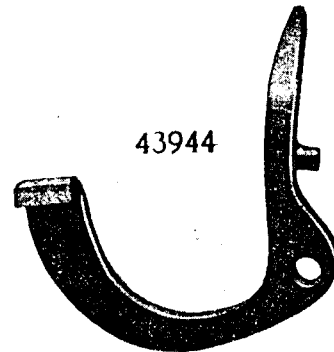
12408



19327



43944



21043



12150



2827



8505



21042



4303



4302



from the library of: Diamond Need Co

PLATE 7429—FULL SIZE

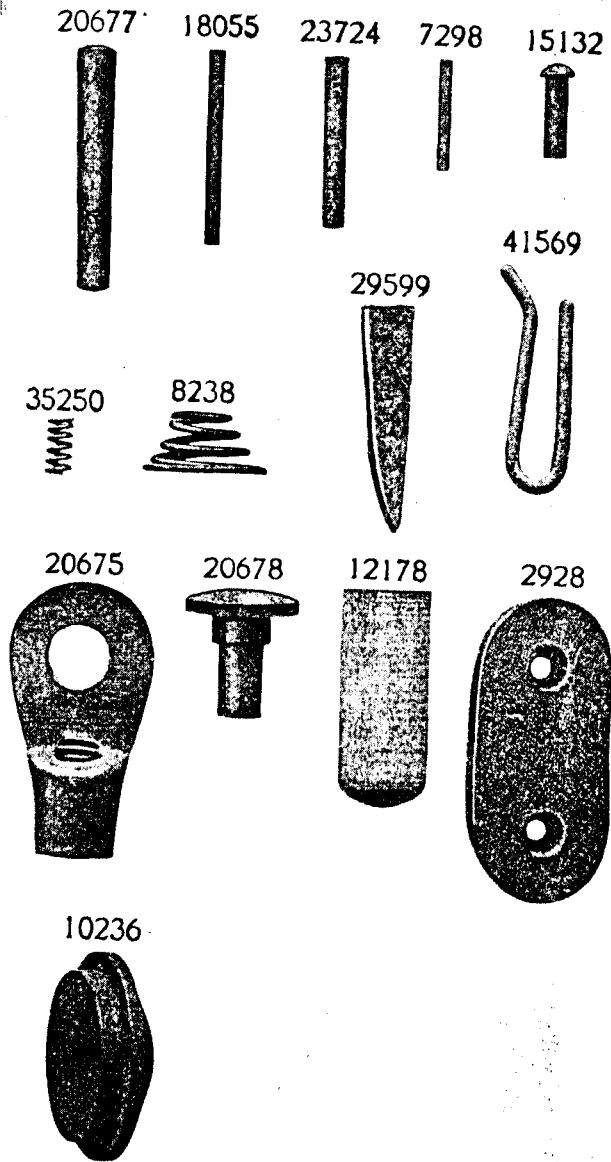
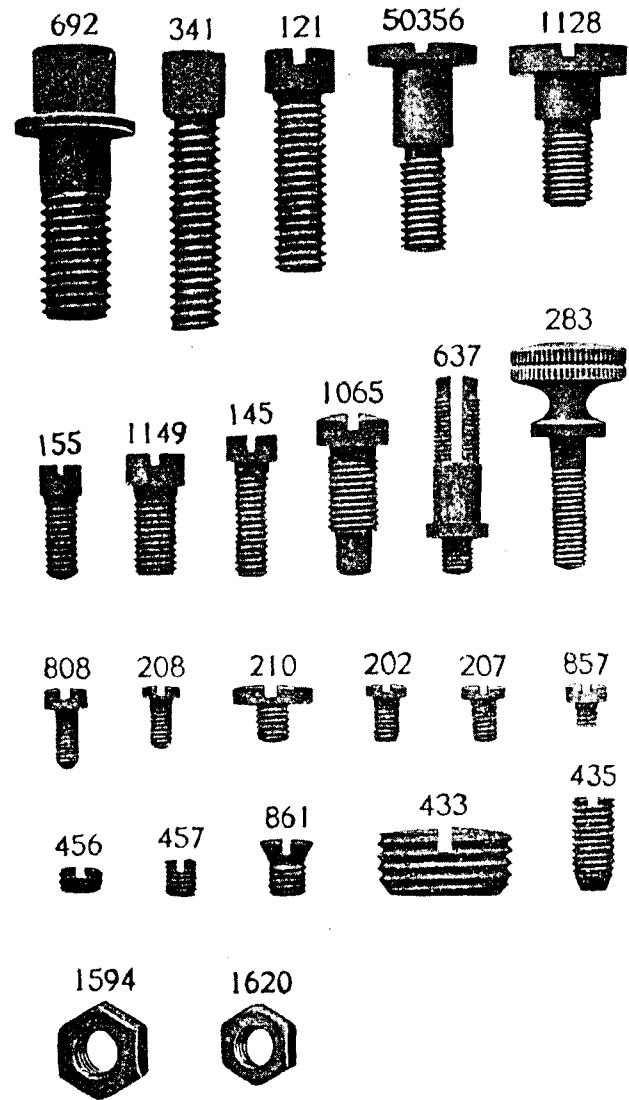


PLATE 7430—FULL SIZE



From the library of: Diamond Needle Corp

PLATE 7431—ONE-FOURTH SIZE

27072

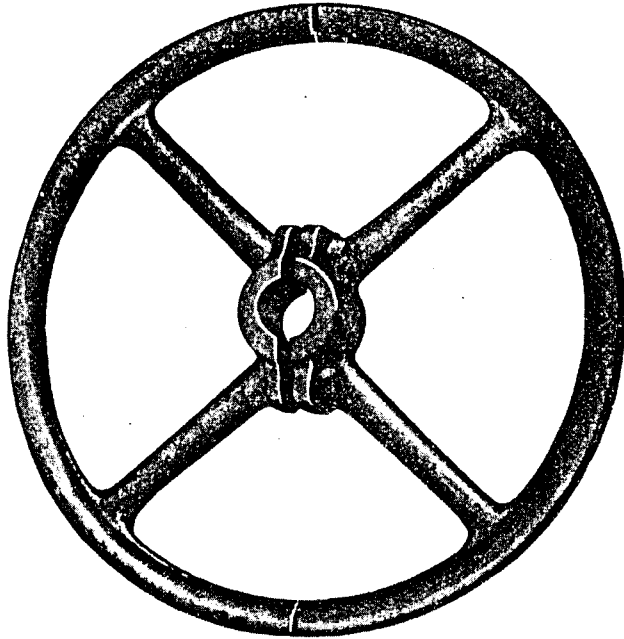
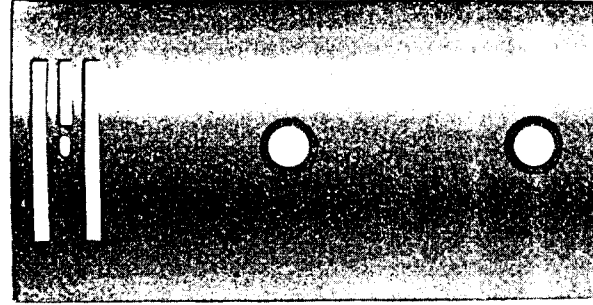
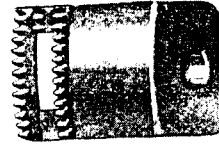


PLATE 7432—FULL SIZE

20699



20573



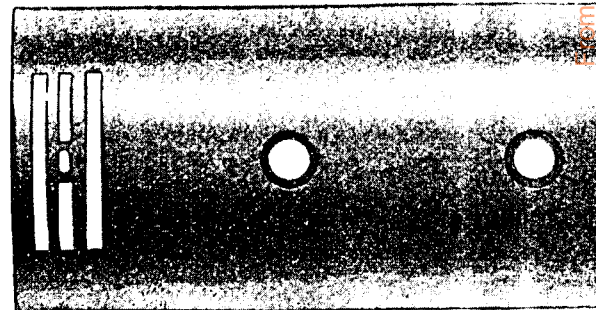
20587



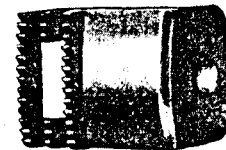
20588



20748



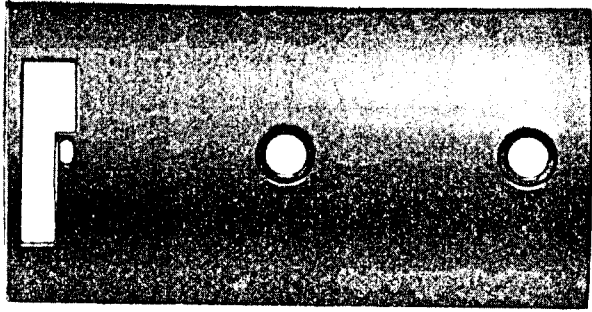
20579



From the library of: *Eastman Kodak Corp*

PLATE 7433—FULL SIZE

20709



20577

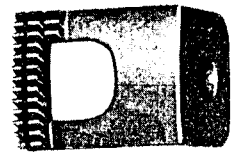
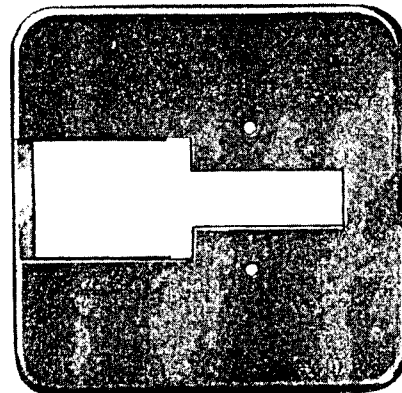
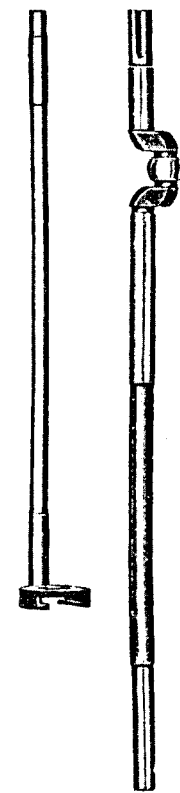


PLATE 7434—ONE-FOURTH SIZE

20564



21030 12427



From the library of: Diamond Needle Corp

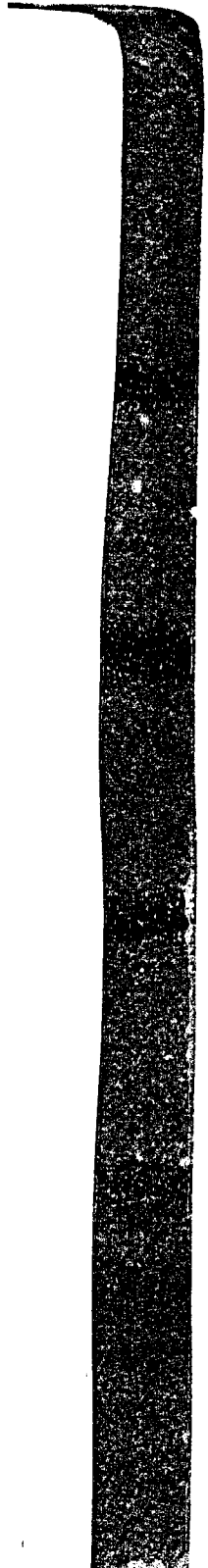


PLATE 7435—ONE-HALF SIZE

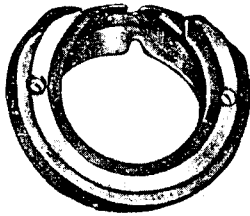
21031



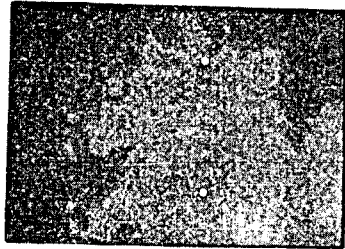
20581



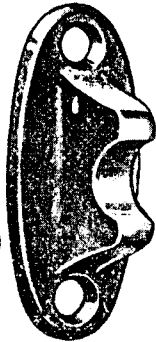
20659



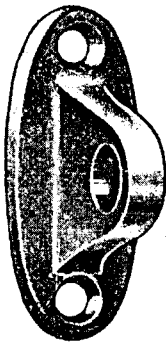
20568



126205



46681



20567

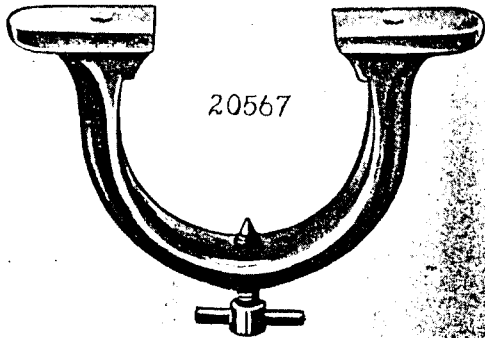
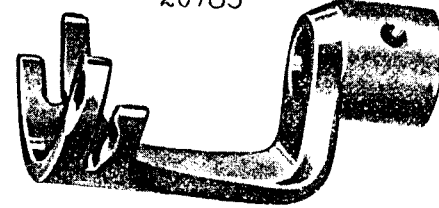
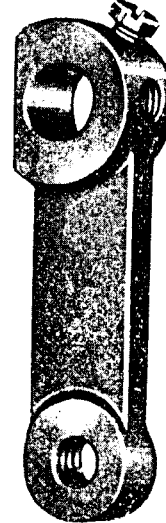


PLATE 7436—FULL SIZE

20783



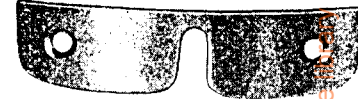
20583



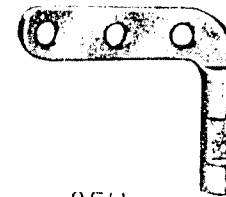
20697



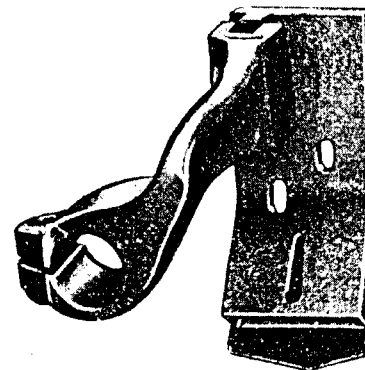
20700



52454



20777



8511



From the files of Diamond Needle Corp

PLATE 7437—FULL SIZE

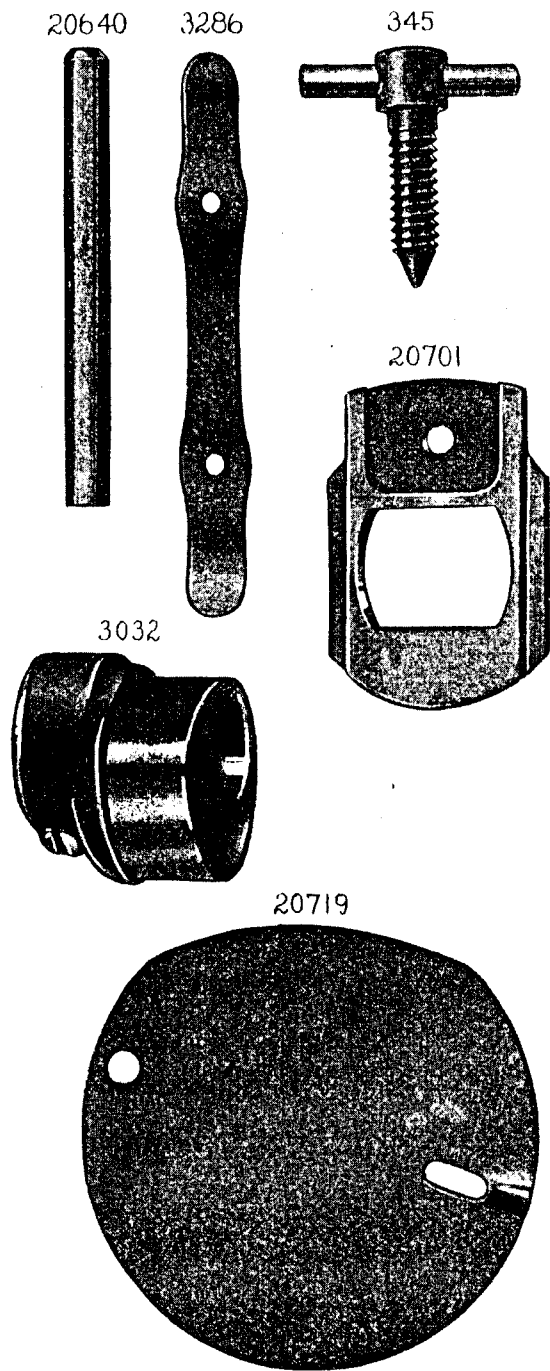
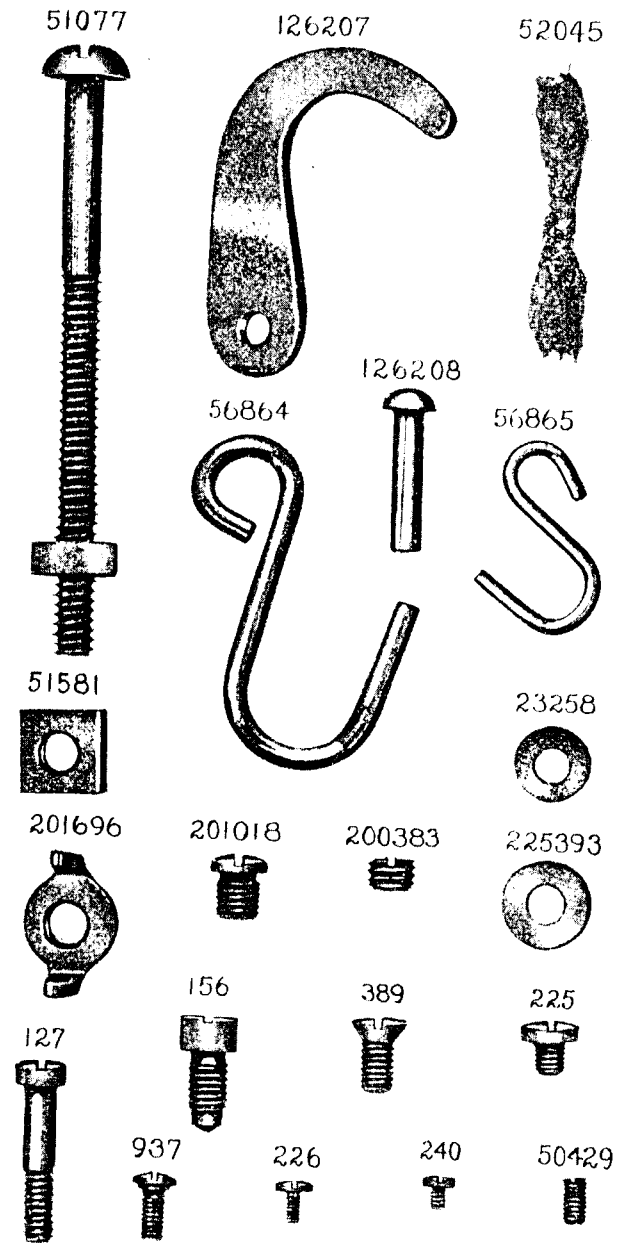
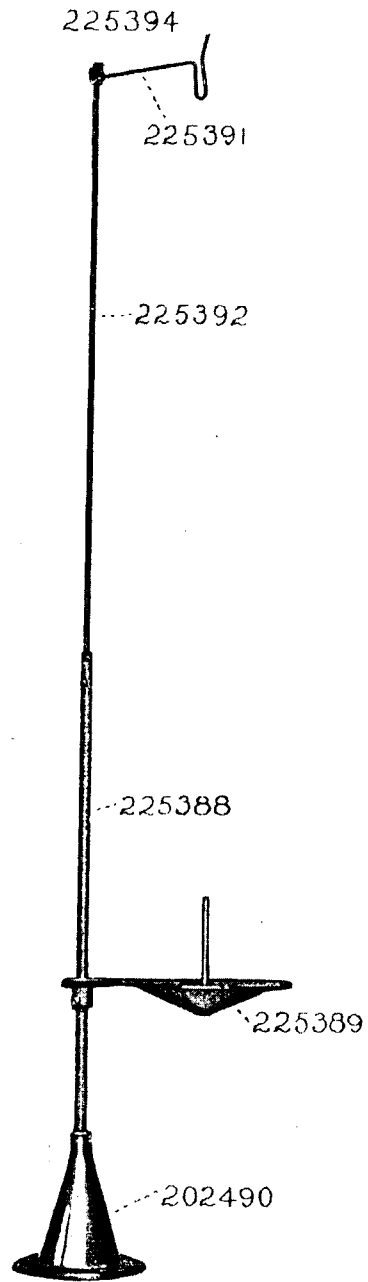


PLATE 7438—FULL SIZE



From the library of: Diamond Needle Corp

PLATE 8523—ONE-SIXTH SIZE



From the library of: Diamond Needle Corp